

# TLV900x Low-Power, RRIO, 1-MHz Operational Amplifier for Cost-Sensitive Systems

## 1 Features

- Scalable CMOS amplifier for low-cost applications
- Rail-to-rail input and output
- Low input offset voltage:  $\pm 0.4$  mV
- Unity-gain bandwidth: 1 MHz
- Low broadband noise:  $27$  nV/ $\sqrt{\text{Hz}}$
- Low input bias current: 5 pA
- Low quiescent current: 60  $\mu\text{A}/\text{Ch}$
- Unity-gain stable
- Internal RFI and EMI filter
- Operational at supply voltages as low as 1.8 V
- Easier to stabilize with higher capacitive load due to resistive open-loop output impedance
- Extended temperature range:  $-40^\circ\text{C}$  to  $125^\circ\text{C}$

## 2 Applications

- Sensor signal conditioning
- Power modules
- Active filters
- Low-side current sensing
- [Smoke detectors](#)
- [Motion detectors](#)
- [Wearable devices](#)
- [Large and small appliances](#)
- [EPOS](#)
- [Barcode scanners](#)
- [Personal electronics](#)
- [HVAC: heating, ventilating, and air conditioning](#)
- [Motor control: AC induction](#)

## 3 Description

The TLV900x family includes single (TLV9001), dual (TLV9002), and quad-channel (TLV9004) low-voltage (1.8 V to 5.5 V) operational amplifiers (op amps) with rail-to-rail input and output swing capabilities. These op amps provide a cost-effective solution for space-constrained applications such as smoke detectors, wearable electronics, and small appliances where low-voltage operation and high capacitive-load drive are required. The capacitive-load drive of the TLV900x family is 500 pF, and the resistive open-loop output impedance makes stabilization easier with much higher capacitive loads. These op amps are designed specifically for low-voltage operation (1.8 V to 5.5 V) with performance specifications similar to the TLV600x devices.

The robust design of the TLV900x family simplifies circuit design. The op amps feature unity-gain stability, an integrated RFI and EMI rejection filter, and no-phase reversal in overdrive conditions.

The TLV900x devices include a shutdown mode (TLV9001S, TLV9002S, and TLV9004S) that allow the amplifiers to switch off into standby mode with typical current consumption less than 1  $\mu\text{A}$ .

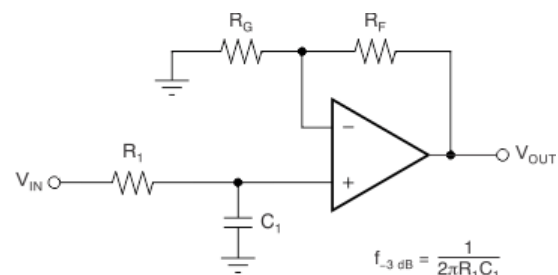
Micro-size packages, such as SOT-553 and WSON, are offered for all channel variants (single, dual, and quad), along with industry-standard packages such as SOIC, MSOP, SOT-23, and TSSOP packages.

### Device Information

PART NUMBER <sup>(1)</sup>	PACKAGE	BODY SIZE (NOM)
TLV9001	SOT-23 (5)	1.60 mm × 2.90 mm
	SC70 (5)	1.25 mm × 2.00 mm
	SOT-553 (5) <sup>(2)</sup>	1.65 mm × 1.20 mm
	X2SON (5)	0.80 mm × 0.80 mm
TLV9001S	SOT-23 (6)	1.60 mm × 2.90 mm
	SC70 (6)	1.25 mm × 2.00 mm
TLV9002	SOIC (8)	3.91 mm × 4.90 mm
	WSON (8)	2.00 mm × 2.00 mm
	VSSOP (8)	3.00 mm × 3.00 mm
	SOT-23 (8)	1.60 mm × 2.90 mm
	TSSOP (8)	3.00 mm × 4.40 mm
TLV9002S	VSSOP (10)	3.00 mm × 3.00 mm
	X2QFN (10)	1.50 mm × 2.00 mm
	DSBGA (9)	1.00 mm × 1.00 mm
TLV9004	SOIC (14)	8.65 mm × 3.91 mm
	SOT-23 (14)	4.20 mm × 2.00 mm
	TSSOP (14)	4.40 mm × 5.00 mm
	WQFN (16)	3.00 mm × 3.00 mm
TLV9004S	X2QFN (14)	2.00 mm × 2.00 mm
	WQFN (16)	3.00 mm × 3.00 mm

(1) For all available packages, see the orderable addendum at the end of the data sheet.

(2) Package is for preview only.



$$\frac{V_{OUT}}{V_{IN}} = \left(1 + \frac{R_F}{R_G}\right) \left(\frac{1}{1 + sR_1C_1}\right)$$

### Single-Pole, Low-Pass Filter



## Table of Contents

<b>1 Features</b> .....	1	8.3 Feature Description.....	26
<b>2 Applications</b> .....	1	8.4 Overload Recovery.....	27
<b>3 Description</b> .....	1	8.5 Shutdown.....	27
<b>4 Revision History</b> .....	2	8.6 Device Functional Modes.....	27
<b>5 Device Comparison Table</b> .....	6	<b>9 Application and Implementation</b> .....	28
<b>6 Pin Configuration and Functions</b> .....	7	9.1 Application Information.....	28
<b>7 Specifications</b> .....	14	9.2 Typical Application.....	28
7.1 Absolute Maximum Ratings.....	14	<b>10 Power Supply Recommendations</b> .....	34
7.2 ESD Ratings.....	14	10.1 Input and ESD Protection.....	34
7.3 Recommended Operating Conditions.....	14	<b>11 Layout</b> .....	35
7.4 Thermal Information: TLV9001.....	15	11.1 Layout Guidelines.....	35
7.5 Thermal Information: TLV9001S.....	15	11.2 Layout Example.....	35
7.6 Thermal Information: TLV9002.....	15	<b>12 Device and Documentation Support</b> .....	36
7.7 Thermal Information: TLV9002S.....	16	12.1 Documentation Support.....	36
7.8 Thermal Information: TLV9004.....	16	12.2 Receiving Notification of Documentation Updates.....	36
7.9 Thermal Information: TLV9004S.....	16	12.3 Support Resources.....	36
7.10 Electrical Characteristics.....	17	12.4 Trademarks.....	36
7.11 Typical Characteristics.....	19	12.5 Electrostatic Discharge Caution.....	36
<b>8 Detailed Description</b> .....	25	12.6 Glossary.....	36
8.1 Overview.....	25	<b>13 Mechanical, Packaging, and Orderable Information</b> .....	37
8.2 Functional Block Diagram.....	25		

## 4 Revision History

NOTE: Page numbers for previous revisions may differ from page numbers in the current version.

### Changes from Revision Q (June 2021) to Revision R (November 2021) Page

• Added SOT-23 (14) package to <i>Device Information</i> table.....	1
• Added SOT-23 DYY package to <i>Device Comparison Table</i> .....	6
• Added SOT-23 (14) package to <i>Pin Configuration and Functions</i> section .....	7
• Added DYY (SOT-23) package thermal information to the <i>Thermal Information: TLV9004</i> table.....	16

### Changes from Revision P (April 2021) to Revision Q (June 2021) Page

• Changed supply voltage (V+) – (V-) MAX from 6 V to 7 V in the <i>Absolute Maximum Ratings</i> table.....	14
--	----

### Changes from Revision O (April 2020) to Revision P (April 2021) Page

• Updated the numbering format for tables, figures, and cross-references throughout the document.....	1
• Added 9-pin DSBGA package to <i>Device Information</i> table.....	1
• Added 9-pin DSBGA package to <i>Device Comparison Table</i> .....	6
• Added TLV9002S 9-pin DSBGA package to <i>Pin Configuration and Functions</i> section.....	7
• Added TLV9002S 9-pin DSBGA package to <i>Thermal Information: TLV9002S</i> .....	16
• Deleted the <i>Related Links</i> section from the <i>Device and Documentation Support</i> section.....	36

### Changes from Revision N (January 2020) to Revision O (April 2020) Page

• Deleted PREVIEW designation on TLV9001S .....	1
• Deleted TLV9001SIDCK (6-pin SC70) package preview note .....	7
• Added DCK (SC70) data to the <i>Thermal Information: TLV9001S</i> table .....	15

<b>Changes from Revision M (September 2019) to Revision N (January 2020)</b>	<b>Page</b>
• Added 6-pin SC70 package to <i>Device Information</i> table.....	1
• Added 6-pin SC70 package to <i>Device Comparison Table</i> .....	6
• Added TLV9001SIDCK (6-Pin SC70) package pinout.....	7
• Added TLV9001S 6-pin SC70 package to <i>Pin Configuration and Functions</i> section.....	7
• Added 6-pin SC70 pinout to <i>Pin Functions: TLV9001S</i> .....	7
• Added TLV9001S 6-pin SC70 package to <i>Thermal Information: TLV9001S</i> table.....	15
<b>Changes from Revision L (May 2019) to Revision M (September 2019)</b>	<b>Page</b>
• Deleted preview notations for SOT-23-8 (DDF) package.....	6
• Added link to <i>Shutdown</i> section in all SHDN pin function rows.....	7
• Added <i>EMI Rejection</i> section to the <i>Feature Description</i> section.....	26
• Changed the <i>Shutdown</i> section to add more clarity regarding internal pull-up resistor.....	27
<b>Changes from Revision K (March 2019) to Revision L (May 2019)</b>	<b>Page</b>
• Added SOT-23 (8) information to <i>Device Information</i> table.....	1
• Added SOT-23 DDF package to <i>Device Comparison Table</i> .....	6
• Added SOT-23 (DDF) to <i>Pin Configuration and Functions</i> section.....	7
• Added DDF (SOT-23) <i>Thermal Information: TLV9002</i> table.....	15
<b>Changes from Revision J (January 2019) to Revision K (March 2019)</b>	<b>Page</b>
• Changed TLV9002S <i>ESD Ratings</i> heading to include all TLV9002S packages.....	14
• Deleted preview notation from TLV9002SIRUG in <i>Thermal Information</i> table.....	16
<b>Changes from Revision I (November 2018) to Revision J (January 2019)</b>	<b>Page</b>
• Deleted preview notation for TLV9002SIRUGR.....	1
• Changed TLV9004 WQFN(14) package designator to X2QFN(14) package designator.....	1
• Added RUG package to <i>Device Comparison Table</i> .....	6
• Added DGS package to <i>Device Comparison Table</i> .....	6
• Added shutdown devices to <i>Device Comparison Table</i> .....	6
• Changed TLV9001 DRL package pinout drawing.....	7
• Changed TLV9001 DRL package pin functions.....	7
• Deleted package preview note from TLV9002SIRUGR (X2QFN) pinout drawing.....	7
• Added TLV9004IRUC Thermal Information.....	16
• Changed legend of Closed-Loop Gain vs Frequency plot.....	19
<b>Changes from Revision H (October 2018) to Revision I (November 2018)</b>	<b>Page</b>
• Added TLV9002SIDGS to <i>ESD Ratings</i> table.....	14
<b>Changes from Revision G (September 2018) to Revision H (October 2018)</b>	<b>Page</b>
• Changed From: TLV9001 DCK Package To: TLV9001T DCK Package.....	7
<b>Changes from Revision F (August 2018) to Revision G (September 2018)</b>	<b>Page</b>
• Added <i>Device Comparison Table</i> .....	6
• Changed pin names for all devices and all packages.....	7
• Changed pin names and I/O designation on some TLV9001 pins .....	7
• Changed the pin number for V+ in the <i>SOIC, TSSOP</i> column of the <i>Pin Functions: TLV9004</i> table.....	7
<b>Changes from Revision E (July 2018) to Revision F (August 2018)</b>	<b>Page</b>
• Added Scalabe CMOS Amplifier for Low-Cost Applications feature.....	1
• Deleted PREVIEW designation on TLV9002 and TLV9004 devices with the TSSOP package. ....	1
• Added TLV9001U DBV (SOT-23) pinout drawing to <i>Pin Configuration and Functions</i> section .....	7

- Added SOT-23 U Pinout to *Pin Functions* section ..... 7

<b>Changes from Revision D (June 2018) to Revision E (July 2018)</b>	<b>Page</b>
--	-------------

- |   |    |
|---|----|
| • Corrected typo in <i>Description</i> section .....  | 1  |
| • Added TLV9001 5-pin X2SON package to <i>Device Information</i> table .....                      | 1  |
| • Added TLV9001S 6-pin SOT-23 package to <i>Device Information</i> table.....                     | 1  |
| • Added TLV9004 14-pin and 16-pin WQFN packages to <i>Device Information</i> table .....          | 1  |
| • Added TLV9001 DPW (X2SON) pinout drawing to <i>Pin Configuration and Functions</i> section..... | 7  |
| • Added TLV9001S 6-pin SOT-23 package to <i>Pin Configuration and Functions</i> section.....      | 7  |
| • Added TLV9004 RTE pinout information to <i>Pin Configuration and Functions</i> section .....    | 7  |
| • Added DPW (X2SON) and DRL (SOT-553) packages to <i>Thermal Information: TLV9001</i> table.....  | 15 |
| • Added <i>Thermal Information: TLV9001S</i> table to <i>Specifications</i> section.....          | 15 |
| • Added RUG (X2QFN) package to <i>Thermal Information: TLV9002</i> table.....                     | 15 |
| • Added RTE (WQFN) and RUC (WQFN) packages to <i>Thermal Information: TLV9004</i> table.....      | 16 |

<b>Changes from Revision C (May 2018) to Revision D (June 2018)</b>	<b>Page</b>
---	-------------

- |   |    |
|---|----|
| • Added shutdown text to <i>Description</i> section.....  | 1  |
| • Added TLV9002S and TLV9004S devices to <i>Device Information</i> table.....   | 1  |
| • Added TLV9002S 10-pin X2QFN package to <i>Device Information</i> table.....   | 1  |
| • Added TLV9002S DGS package pinout information to <i>Pin Configurations and Functions</i> section.....                                       | 7  |
| • Added <i>Thermal Information: TLV9001</i> table to <i>Specifications</i> section.....   | 15 |
| • Added <i>Thermal Information: TLV9004</i> table to <i>Specifications</i> section.....   | 16 |
| • Added shutdown section to <i>Electrical Characteristics: V<sub>S</sub> (Total Supply Voltage) = (V+) – (V-) = 1.8 V to 5.5 V</i> table..... | 17 |
| • Added <i>Shutdown</i> section.....  | 27 |

<b>Changes from Revision B (March 2018) to Revision C (May 2018)</b>	<b>Page</b>
--	-------------

- |   |    |
|---|----|
| • Added TLV9002 16-pin TSSOP package to <i>Device Information</i> table.....  | 1  |
| • Added TLV9002 10-pin X2QFN package to <i>Device Information</i> table.....  | 1  |
| • Added TLV9002S DGS package pinout drawing in <i>Pin Configurations and Functions</i> section.....                 | 7  |
| • Added TLV9004 pinout diagram and pin configuration table to <i>Pin Configuration and Functions</i> section .....  | 7  |
| • Added TLV9004S pinout diagram and pin configuration table to <i>Pin Configuration and Functions</i> section ..... | 7  |
| • Changed TLV9002 D (SOIC) junction-to-ambient thermal resistance value from 147.4°C/W to 207.9°C/W...              | 15 |
| • Changed TLV9002 D (SOIC) junction-to-case (top) thermal resistance from 94.3°C/W to 92.8°C/W.....                 | 15 |
| • Changed TLV9002 D (SOIC) junction-to-board thermal resistance from 89.5°C/W to 129.7°C/W.....                     | 15 |
| • Changed TLV9002 D (SOIC) junction-to-top characterization parameter from 47.3°C/W to 26°C/W.....                  | 15 |
| • Changed TLV9002 D (SOIC) junction-to-board characterization parameter from 89°C/W to 127.9°C/W.....               | 15 |
| • Added DGK (VSSOP) thermal information to <i>Thermal Information: TLV9002</i> table .....                          | 15 |
| • Added TLV9002 PW (TSSOP) thermal information to <i>Thermal Information: TLV9002</i> table.....                    | 15 |
| • Added PW (TSSOP) thermal information to <i>Thermal Information: TLV9002</i> table .....                           | 16 |

<b>Changes from Revision A (December 2017) to Revision B (March 2018)</b>	<b>Page</b>
---	-------------

- |   |    |
|---|----|
| • Added package preview notes to TLV9001 packages, TLV9004 packages, and TLV9002 8-pin VSSOP package in <i>Device Information</i> table .....       | 1  |
| • Added package preview notes to TLV9001, TLV9004 and TLV9002 VSSOP package pinout drawings in <i>Pin Configuration and Functions</i> section ..... | 7  |
| • Deleted package preview note from TLV9002 DSG (WSON) pinout drawing in <i>Pin Configurations and Functions</i> section.....                       | 7  |
| • Deleted package preview note from TLV9002 RUG (X2QFN) pinout drawing in <i>Pin Configurations and Functions</i> section.....                      | 7  |
| • Added DSG (WSON) package thermal information to the <i>Thermal Information: TLV9002</i> table.....  | 15 |
| • Deleted package preview note from DSG (WSON) package in <i>Thermal Information: TLV9002</i> table.....  | 15 |
| • Added D (SOIC) package thermal information to the <i>Thermal Information: TLV9004</i> table.....  | 16 |

---

**Changes from Revision \* (October 2017) to Revision A (December 2017)**

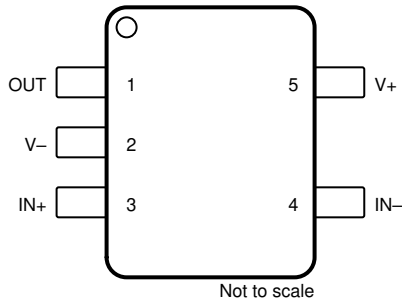
**Page**

- Changed device status from Advance Information to Production Data/Mixed Status..... **1**
-

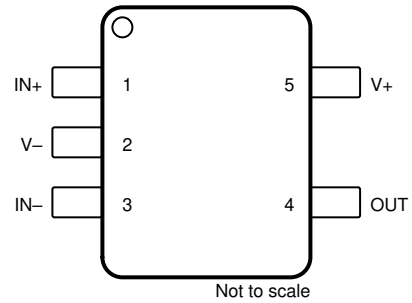
## 5 Device Comparison Table

DEVICE	NO. OF CH.	PACKAGE LEADS														
		SC70 DCK	SOIC D	SOT-23 DBV	SOT-23 DYY	SOT-553 DRL	TSSOP PW	VSSOP DGK	SOT-23 DDF	WQFN RTE	WSOP DSG	X2QFN RUC	X2SON DPW	X2QFN RUG	VSSOP DGS	DSBGA YCK
TLV9001	1	5	—	5	—	5	—	—	—	—	—	—	5	—	—	—
TLV9001S		6	—	6	—	—	—	—	—	—	—	—	—	—	—	—
TLV9002	2	—	8	—	—	—	8	8	8	—	8	—	—	—	—	—
TLV9002S		—	—	—	—	—	—	—	—	—	—	—	—	10	10	9
TLV9004	4	—	14	—	14	—	14	—	—	16	—	14	—	—	—	—
TLV9004S		—	—	—	—	—	—	—	—	16	—	—	—	—	—	—

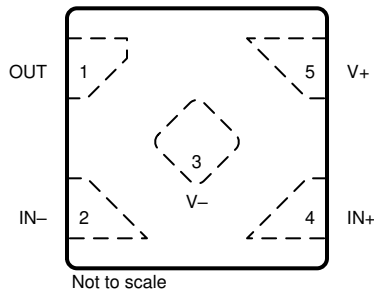
## 6 Pin Configuration and Functions



**Figure 6-1. TLV9001 DBV, TLV9001T DCK Package  
5-Pin SOT-23, SC70  
Top View**



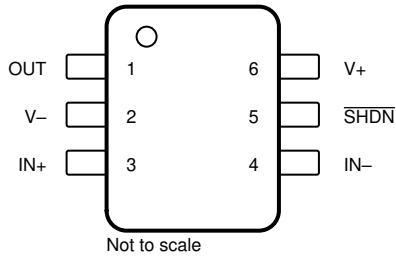
**Figure 6-2. TLV9001 DCK Package, TLV9001 DRL  
Package, TLV9001U DBV Package  
5-Pin SC70, SOT-553, SOT-23  
Top View**



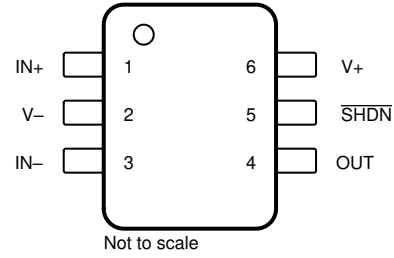
**Figure 6-3. TLV9001 DPW Package  
5-Pin X2SON  
Top View**

**Table 6-1. Pin Functions: TLV9001**

NAME	PIN			I/O	DESCRIPTION
	SOT-23, SC70(T)	SC70, SOT-23(U), SOT-553	X2SON		
IN-	4	3	2	I	Inverting input
IN+	3	1	4	I	Noninverting input
OUT	1	4	1	O	Output
V-	2	2	3	I or —	Negative (low) supply or ground (for single-supply operation)
V+	5	5	5	I	Positive (high) supply



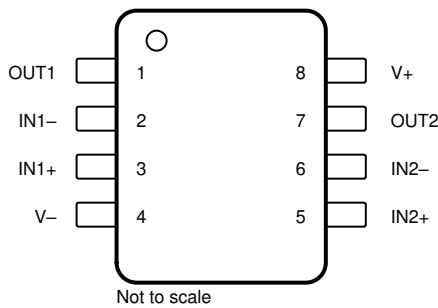
**Figure 6-4. TLV9001S DBV Package  
6-Pin SOT-23  
Top View**



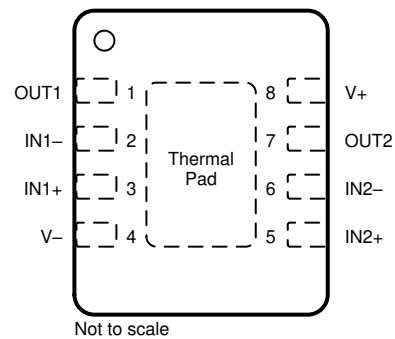
**Figure 6-5. TLV9001S DCK Package  
6-Pin SC70  
Top View**

**Table 6-2. Pin Functions: TLV9001S**

NAME	PIN		I/O	DESCRIPTION
	SOT-23	SC70		
IN-	4	3	I	Inverting input
IN+	3	1	I	Noninverting input
OUT	1	4	O	Output
SHDN	5	5	I	Shutdown: low = amp disabled, high = amp enabled. See <a href="#">Section 8.5</a> for more information.
V-	2	2	I or —	Negative (low) supply or ground (for single-supply operation)
V+	6	6	I	Positive (high) supply



**Figure 6-6. TLV9002 D, DGK, PW, DDF Package  
8-Pin SOIC, VSSOP, TSSOP, SOT-23  
Top View**



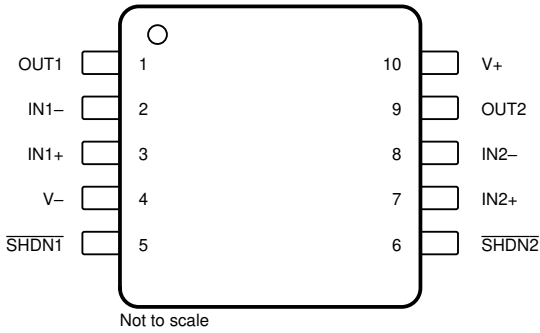
A. Connect thermal pad to V-.

**Figure 6-7. TLV9002 DSG Package  
8-Pin WSON With Exposed Thermal Pad  
Top View**

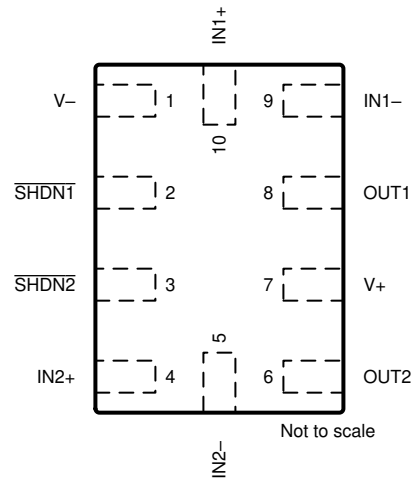
**Table 6-3. Pin Functions: TLV9002**

NAME	PIN		I/O	DESCRIPTION
	NO.			
IN1-	2		I	Inverting input, channel 1
IN1+	3		I	Noninverting input, channel 1
IN2-	6		I	Inverting input, channel 2
IN2+	5		I	Noninverting input, channel 2
OUT1	1		O	Output, channel 1
OUT2	7		O	Output, channel 2
V-	4		I or —	Negative (low) supply or ground (for single-supply operation)
V+	8		I	Positive (high) supply

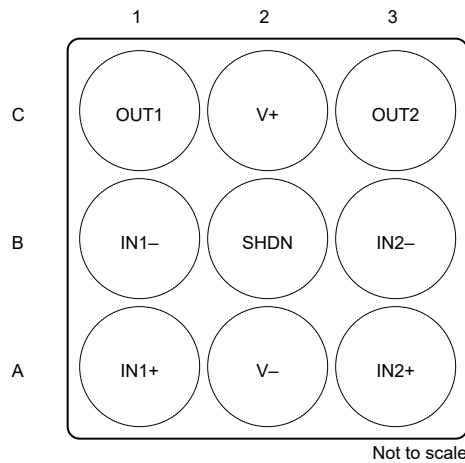




**Figure 6-8. TLV9002S DGS Package 10-Pin VSSOP Top View**



**Figure 6-9. TLV9002S RUG Package 10-Pin X2QFN Top View**



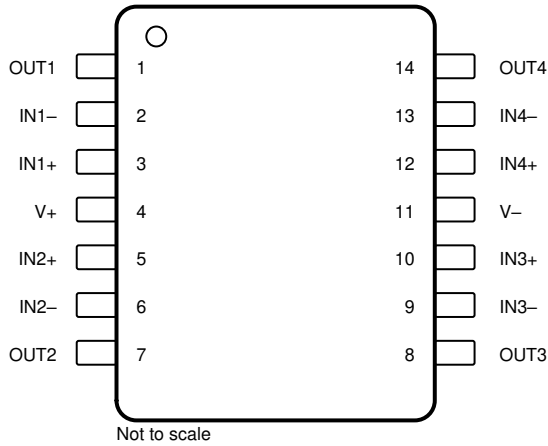
**Figure 6-10. TLV9002S YCK Package 9-Pin DSBGA (WCSP) Bottom View**

**Table 6-4. Pin Functions: TLV9002S**

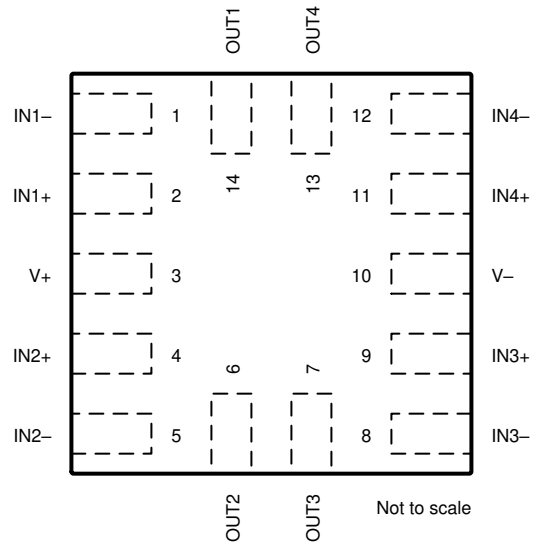
NAME	PIN			I/O	DESCRIPTION
	VSSOP	X2QFN	DSBGA (WCSP)		
IN1-	2	9	B1	I	Inverting input, channel 1
IN1+	3	10	A1	I	Noninverting input, channel 1
IN2-	8	5	B3	I	Inverting input, channel 2
IN2+	7	4	A3	I	Noninverting input, channel 2
OUT1	1	8	C1	O	Output, channel 1
OUT2	9	6	C3	O	Output, channel 2
SHDN1	5	2	—	I	Shutdown: low = amp disabled, high = amp enabled, channel 1. See <a href="#">Section 8.5</a> for more information.

**Table 6-4. Pin Functions: TLV9002S (continued)**

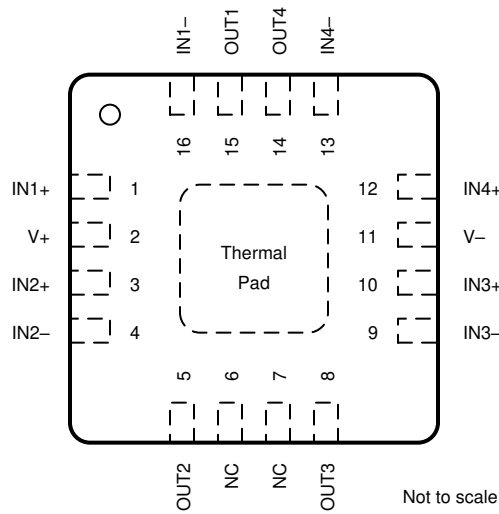
PIN				I/O	DESCRIPTION
NAME	VSSOP	X2QFN	DSBGA (WCSP)		
$\overline{\text{SHDN}}_2$	6	3	—	I	Shutdown: low = amp disabled, high = amp enabled, channel 1. See <a href="#">Section 8.5</a> for more information.
$\overline{\text{SHDN}}$	—	—	B2		Shutdown: low = both amplifiers disabled, high = both amplifiers enabled
V-	4	1	A2	I or —	Negative (low) supply or ground (for single-supply operation)
V+	10	7	C2	I	Positive (high) supply



**Figure 6-11. TLV9004 D, DYY, PW Package 14-Pin SOIC, SOT-23 (14), TSSOP Top View**



**Figure 6-12. TLV9004 RUC Package 14-Pin X2QFN Top View**



**Figure 6-13. TLV9004 RTE Package 16-Pin WQFN With Exposed Thermal Pad Top View**

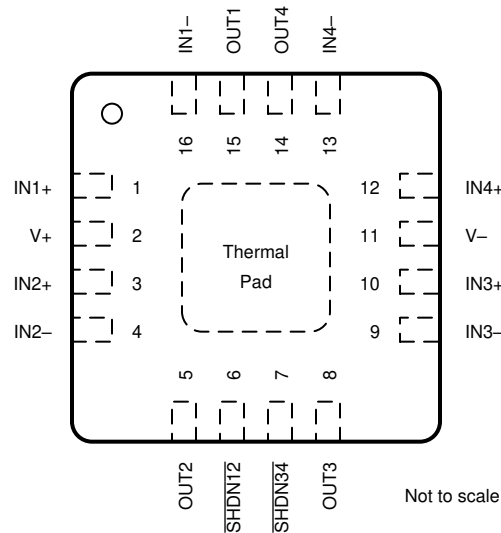
A. Connect thermal pad to V-.

**Table 6-5. Pin Functions: TLV9004**

NAME	PIN			I/O	DESCRIPTION
	SOIC, SOT-23 (14), TSSOP	WQFN	X2QFN		
IN1-	2	16	1	I	Inverting input, channel 1
IN1+	3	1	2	I	Noninverting input, channel 1
IN2-	6	4	5	I	Inverting input, channel 2
IN2+	5	3	4	I	Noninverting input, channel 2

**Table 6-5. Pin Functions: TLV9004 (continued)**

NAME	PIN			I/O	DESCRIPTION
	SOIC, SOT-23 (14), TSSOP	WQFN	X2QFN		
IN3–	9	9	8	I	Inverting input, channel 3
IN3+	10	10	9	I	Noninverting input, channel 3
IN4–	13	13	12	I	Inverting input, channel 4
IN4+	12	12	11	I	Noninverting input, channel 4
NC	—	6, 7	—	—	No internal connection
OUT1	1	15	14	O	Output, channel 1
OUT2	7	5	6	O	Output, channel 2
OUT3	8	8	7	O	Output, channel 3
OUT4	14	14	13	O	Output, channel 4
V–	11	11	10	I or —	Negative (low) supply or ground (for single-supply operation)
V+	4	2	3	I	Positive (high) supply



A. Connect thermal pad to V-.

**Figure 6-14. TLV9004S RTE Package  
16-Pin WQFN With Exposed Thermal Pad  
Top View**

**Table 6-6. Pin Functions: TLV9004S**

PIN		I/O	DESCRIPTION
NAME	NO.		
IN1+	1	I	Noninverting input
IN1-	16	I	Inverting input
IN2+	3	I	Noninverting input
IN2-	4	I	Inverting input
IN3+	10	I	Noninverting input
IN3-	9	I	Inverting input
IN4+	12	I	Noninverting input
IN4-	13	I	Inverting input
SHDN12	6	I	Shutdown: low = amp disabled, high = amp enabled, channel 1 and 2. See <a href="#">Section 8.5</a> for more information.
SHDN34	7	I	Shutdown: low = amp disabled, high = amp enabled, channel 3 and 4. See <a href="#">Section 8.5</a> for more information.
OUT1	15	O	Output
OUT2	5	O	Output
OUT3	8	O	Output
OUT4	14	O	Output
V-	11	I or —	Negative (low) supply or ground (for single-supply operation)
V+	2	I	Positive (high) supply

## 7 Specifications

### 7.1 Absolute Maximum Ratings

over operating temperature range (unless otherwise noted)<sup>(1)</sup>

		MIN	MAX	UNIT	
Supply voltage (V+) – (V–)			7	V	
Signal input pins	Voltage <sup>(2)</sup>	Common-mode	(V–) – 0.5	(V+) + 0.5	V
		Differential	(V+) – (V–) + 0.2		V
	Current <sup>(2)</sup>	–10	10	mA	
Output short-circuit <sup>(3)</sup>		Continuous			
Operating, T <sub>A</sub>		–55	150	°C	
Junction, T <sub>J</sub>			150	°C	
Storage, T <sub>stg</sub>		–65	150	°C	

- (1) Stresses beyond those listed under *Absolute Maximum Ratings* may cause permanent damage to the device. These are stress ratings only, which do not imply functional operation of the device at these or any other conditions beyond those indicated under *Recommended Operating Conditions*. Exposure to absolute-maximum-rated conditions for extended periods may affect device reliability.
- (2) Input pins are diode-clamped to the power-supply rails. Input signals that may swing more than 0.5 V beyond the supply rails must be current limited to 10 mA or less.
- (3) Short-circuit to ground, one amplifier per package.

### 7.2 ESD Ratings

TLV9002S PACKAGE		VALUE	UNIT	
V <sub>(ESD)</sub>	Electrostatic discharge	Human-body model (HBM), per ANSI/ESDA/JEDEC JS-001 <sup>(1)</sup>	±1500	V
		Charged-device model (CDM), per JEDEC specification JESD22-C101 <sup>(2)</sup>	±1500	
ALL OTHER PACKAGES				
V <sub>(ESD)</sub>	Electrostatic discharge	Human-body model (HBM), per ANSI/ESDA/JEDEC JS-001 <sup>(1)</sup>	±2000	V
		Charged-device model (CDM), per JEDEC specification JESD22-C101 <sup>(2)</sup>	±1000	

- (1) JEDEC document JEP155 states that 500-V HBM allows safe manufacturing with a standard ESD control process.
- (2) JEDEC document JEP157 states that 250-V CDM allows safe manufacturing with a standard ESD control process.

### 7.3 Recommended Operating Conditions

over operating temperature range (unless otherwise noted)

		MIN	MAX	UNIT
V <sub>S</sub>	Supply voltage	1.8	5.5	V
T <sub>A</sub>	Specified temperature	–40	125	°C

## 7.4 Thermal Information: TLV9001

THERMAL METRIC <sup>(1)</sup>		TLV9001				UNIT
		DBV (SOT-23)	DCK (SC70)	DPW (X2SON)	DRL (SOT-553) <sup>(2)</sup>	
		5 PINS	5 PINS	5 PINS	5 PINS	
$R_{\theta JA}$	Junction-to-ambient thermal resistance	232.9	239.6	470.0	TBD	°C/W
$R_{\theta JC(top)}$	Junction-to-case (top) thermal resistance	153.8	148.5	211.9	TBD	°C/W
$R_{\theta JB}$	Junction-to-board thermal resistance	100.9	82.3	334.8	TBD	°C/W
$\Psi_{JT}$	Junction-to-top characterization parameter	77.2	54.5	29.8	TBD	°C/W
$\Psi_{JB}$	Junction-to-board characterization parameter	100.4	81.8	333.2	TBD	°C/W

- (1) For more information about traditional and new thermal metrics, see [Semiconductor and IC Package Thermal Metrics](#).  
(2) This package option for TLV9001 is preview only.

## 7.5 Thermal Information: TLV9001S

THERMAL METRIC <sup>(1)</sup>		TLV9001S		UNIT
		DBV (SOT-23)	DCK (SC70)	
		6 PINS	6 PINS	
$R_{\theta JA}$	Junction-to-ambient thermal resistance	232.9	215.6	°C/W
$R_{\theta JC(top)}$	Junction-to-case (top) thermal resistance	153.8	146.4	°C/W
$R_{\theta JB}$	Junction-to-board thermal resistance	100.9	72.0	°C/W
$\Psi_{JT}$	Junction-to-top characterization parameter	77.2	55.0	°C/W
$\Psi_{JB}$	Junction-to-board characterization parameter	100.4	71.7	°C/W

- (1) For more information about traditional and new thermal metrics, see [Semiconductor and IC Package Thermal Metrics](#).

## 7.6 Thermal Information: TLV9002

THERMAL METRIC <sup>(1)</sup>		TLV9002						UNIT
		D (SOIC)	DGK (VSSOP)	DGS (VSSOP)	DSG (WSON)	PW (TSSOP)	DDF (SOT-23)	
		8 PINS	8 PINS	10 PINS	8 PINS	8 PINS	8 PINS	
$R_{\theta JA}$	Junction-to-ambient thermal resistance	207.9	201.2	169.5	103.2	200.7	183.7	°C/W
$R_{\theta JC(top)}$	Junction-to-case (top) thermal resistance	92.8	85.7	84.1	120.1	95.4	112.5	°C/W
$R_{\theta JB}$	Junction-to-board thermal resistance	129.7	122.9	113	68.8	128.6	98.2	°C/W
$\Psi_{JT}$	Junction-to-top characterization parameter	26	21.2	15.8	14.7	27.2	18.8	°C/W
$\Psi_{JB}$	Junction-to-board characterization parameter	127.9	121.4	111.6	68.5	127.2	97.6	°C/W

- (1) For more information about traditional and new thermal metrics, see [Semiconductor and IC Package Thermal Metrics](#).

## 7.7 Thermal Information: TLV9002S

THERMAL METRIC <sup>(1)</sup>		TLV9002S			UNIT
		DGS (VSSOP)	RUG (X2QFN)	YCK (DSBGA)	
		10 PINS	10 PINS	9 PINS	
$R_{\theta JA}$	Junction-to-ambient thermal resistance	169.5	194.2	101.2	°C/W
$R_{\theta JC(top)}$	Junction-to-case (top) thermal resistance	84.1	90.3	0.9	°C/W
$R_{\theta JB}$	Junction-to-board thermal resistance	113	122.2	33.8	°C/W
$\Psi_{JT}$	Junction-to-top characterization parameter	15.8	3.5	0.5	°C/W
$\Psi_{JB}$	Junction-to-board characterization parameter	111.6	118.8	33.8	°C/W

(1) For more information about traditional and new thermal metrics, see [Semiconductor and IC Package Thermal Metrics](#).

## 7.8 Thermal Information: TLV9004

THERMAL METRIC <sup>(1)</sup>		TLV9004					UNIT
		D (SOIC)	DYY (SOT-23)	PW (TSSOP)	RTE (WQFN)	RUC (X2QFN)	
		14 PINS	14 PINS	14 PINS	16 PINS	14 PINS	
$R_{\theta JA}$	Junction-to-ambient thermal resistance	102.1	154.3	148.3	66.4	205.5	°C/W
$R_{\theta JC(top)}$	Junction-to-case (top) thermal resistance	56.8	86.8	68.1	69.3	72.5	°C/W
$R_{\theta JB}$	Junction-to-board thermal resistance	58.5	67.9	92.7	41.7	150.2	°C/W
$\Psi_{JT}$	Junction-to-top characterization parameter	20.5	10.1	16.9	5.7	3.0	°C/W
$\Psi_{JB}$	Junction-to-board characterization parameter	58.1	67.5	91.8	41.5	149.6	°C/W

(1) For more information about traditional and new thermal metrics, see [Semiconductor and IC Package Thermal Metrics](#).

## 7.9 Thermal Information: TLV9004S

THERMAL METRIC <sup>(1)</sup>		TLV9004S	UNIT
		RTE (WQFN)	
		16 PINS	
$R_{\theta JA}$	Junction-to-ambient thermal resistance	66.4	°C/W
$R_{\theta JC(top)}$	Junction-to-case (top) thermal resistance	69.3	°C/W
$R_{\theta JB}$	Junction-to-board thermal resistance	41.7	°C/W
$\Psi_{JT}$	Junction-to-top characterization parameter	5.7	°C/W
$\Psi_{JB}$	Junction-to-board characterization parameter	41.5	°C/W

(1) For more information about traditional and new thermal metrics, see [Semiconductor and IC Package Thermal Metrics](#).



## 7.10 Electrical Characteristics

For  $V_S = (V+) - (V-) = 1.8\text{ V to }5.5\text{ V}$  ( $\pm 0.9\text{ V to } \pm 2.75\text{ V}$ ),  $T_A = 25^\circ\text{C}$ ,  $R_L = 10\text{ k}\Omega$  connected to  $V_S / 2$ , and  $V_{CM} = V_{OUT} = V_S / 2$  (unless otherwise noted)

PARAMETER		TEST CONDITIONS	MIN	TYP	MAX	UNIT
<b>OFFSET VOLTAGE</b>						
$V_{OS}$	Input offset voltage	$V_S = 5\text{ V}$		$\pm 0.4$	$\pm 1.6$	mV
		$V_S = 5\text{ V}$ , $T_A = -40^\circ\text{C to }125^\circ\text{C}$			$\pm 2$	
$dV_{OS}/dT$	$V_{OS}$ vs temperature	$T_A = -40^\circ\text{C to }125^\circ\text{C}$		$\pm 0.6$		$\mu\text{V}/^\circ\text{C}$
PSRR	Power-supply rejection ratio	$V_S = 1.8\text{ to }5.5\text{ V}$ , $V_{CM} = (V-)$	80	105		dB
<b>INPUT VOLTAGE RANGE</b>						
$V_{CM}$	Common-mode voltage range	No phase reversal, rail-to-rail input	$(V-) - 0.1$		$(V+) + 0.1$	V
CMRR	Common-mode rejection ratio	$V_S = 1.8\text{ V}$ , $(V-) - 0.1\text{ V} < V_{CM} < (V+) - 1.4\text{ V}$ , $T_A = -40^\circ\text{C to }125^\circ\text{C}$		86		dB
		$V_S = 5.5\text{ V}$ , $(V-) - 0.1\text{ V} < V_{CM} < (V+) - 1.4\text{ V}$ , $T_A = -40^\circ\text{C to }125^\circ\text{C}$		95		
		$V_S = 5.5\text{ V}$ , $(V-) - 0.1\text{ V} < V_{CM} < (V+) + 0.1\text{ V}$ , $T_A = -40^\circ\text{C to }125^\circ\text{C}$	63	77		
		$V_S = 1.8\text{ V}$ , $(V-) - 0.1\text{ V} < V_{CM} < (V+) + 0.1\text{ V}$ , $T_A = -40^\circ\text{C to }125^\circ\text{C}$		68		
<b>INPUT BIAS CURRENT</b>						
$I_B$	Input bias current	$V_S = 5\text{ V}$		$\pm 5$		pA
$I_{OS}$	Input offset current			$\pm 2$		pA
<b>NOISE</b>						
$E_n$	Input voltage noise (peak-to-peak)	$f = 0.1\text{ Hz to }10\text{ Hz}$ , $V_S = 5\text{ V}$		4.7		$\mu\text{V}_{PP}$
$e_n$	Input voltage noise density	$f = 1\text{ kHz}$ , $V_S = 5\text{ V}$		30		$\text{nV}/\sqrt{\text{Hz}}$
		$f = 10\text{ kHz}$ , $V_S = 5\text{ V}$		27		
$i_n$	Input current noise density	$f = 1\text{ kHz}$ , $V_S = 5\text{ V}$		23		$\text{fA}/\sqrt{\text{Hz}}$
<b>INPUT CAPACITANCE</b>						
$C_{ID}$	Differential			1.5		pF
$C_{IC}$	Common-mode			5		pF
<b>OPEN-LOOP GAIN</b>						
$A_{OL}$	Open-loop voltage gain	$V_S = 5.5\text{ V}$ , $(V-) + 0.05\text{ V} < V_O < (V+) - 0.05\text{ V}$ , $R_L = 10\text{ k}\Omega$	104	117		dB
		$V_S = 1.8\text{ V}$ , $(V-) + 0.04\text{ V} < V_O < (V+) - 0.04\text{ V}$ , $R_L = 10\text{ k}\Omega$		100		
		$V_S = 1.8\text{ V}$ , $(V-) + 0.1\text{ V} < V_O < (V+) - 0.1\text{ V}$ , $R_L = 2\text{ k}\Omega$		115		
		$V_S = 5.5\text{ V}$ , $(V-) + 0.15\text{ V} < V_O < (V+) - 0.15\text{ V}$ , $R_L = 2\text{ k}\Omega$		130		
<b>FREQUENCY RESPONSE</b>						
GBW	Gain-bandwidth product	$V_S = 5\text{ V}$		1		MHz
$\phi_m$	Phase margin	$V_S = 5.5\text{ V}$ , $G = 1$		78		$^\circ$
SR	Slew rate	$V_S = 5\text{ V}$		2		V/ $\mu\text{s}$
$t_s$	Settling time	To 0.1%, $V_S = 5\text{ V}$ , 2-V step, $G = +1$ , $C_L = 100\text{ pF}$		2.5		$\mu\text{s}$
		To 0.01%, $V_S = 5\text{ V}$ , 2-V step, $G = +1$ , $C_L = 100\text{ pF}$		3		
$t_{OR}$	Overload recovery time	$V_S = 5\text{ V}$ , $V_{IN} \times \text{gain} > V_S$		0.85		$\mu\text{s}$
THD+N	Total harmonic distortion + noise	$V_S = 5.5\text{ V}$ , $V_{CM} = 2.5\text{ V}$ , $V_O = 1\text{ V}_{RMS}$ , $G = +1$ , $f = 1\text{ kHz}$ , 80-kHz measurement BW		0.004%		
<b>OUTPUT</b>						
$V_O$	Voltage output swing from supply rails	$V_S = 5.5\text{ V}$ , $R_L = 10\text{ k}\Omega$		10	20	mV
		$V_S = 5.5\text{ V}$ , $R_L = 2\text{ k}\Omega$		35	55	
$I_{SC}$	Short-circuit current	$V_S = 5.5\text{ V}$		$\pm 40$		mA
$Z_O$	Open-loop output impedance	$V_S = 5\text{ V}$ , $f = 1\text{ MHz}$		1200		$\Omega$

## 7.10 Electrical Characteristics (continued)

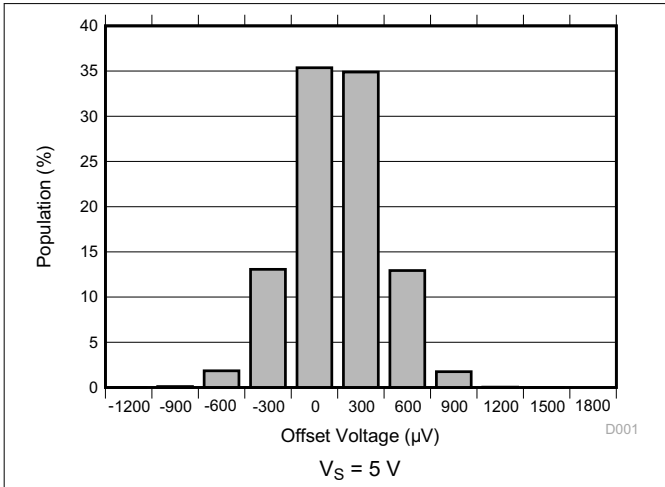
For  $V_S = (V+) - (V-) = 1.8\text{ V to }5.5\text{ V}$  ( $\pm 0.9\text{ V to } \pm 2.75\text{ V}$ ),  $T_A = 25^\circ\text{C}$ ,  $R_L = 10\text{ k}\Omega$  connected to  $V_S / 2$ , and  $V_{CM} = V_{OUT} = V_S / 2$  (unless otherwise noted)

PARAMETER		TEST CONDITIONS	MIN	TYP	MAX	UNIT	
<b>POWER SUPPLY</b>							
$V_S$	Specified voltage range		1.8 ( $\pm 0.9$ )		5.5 ( $\pm 2.75$ )	V	
$I_Q$	Quiescent current per amplifier	TLV9002, TLV9002S TLV9004, TLV9004S	$I_O = 0\text{ mA}$ , $V_S = 5.5\text{ V}$		60	75	$\mu\text{A}$
		TLV9001, TLV9001S		$I_O = 0\text{ mA}$ , $V_S = 5.5\text{ V}$		60	
				$I_O = 0\text{ mA}$ , $V_S = 5.5\text{ V}$ , $T_A = -40^\circ\text{C to }125^\circ\text{C}$			
<b>SHUTDOWN<sup>(1)</sup></b>							
$I_{QSD}$	Quiescent current per amplifier	$V_S = 1.8\text{ V to }5.5\text{ V}$ , all amplifiers disabled, $\overline{\text{SHDN}} = V_{S-}$		0.5	1.5	$\mu\text{A}$	
$Z_{\text{SHDN}}$	Output impedance during shutdown	$V_S = 1.8\text{ V to }5.5\text{ V}$ , amplifier disabled		10    2		$\text{G}\Omega \parallel \text{pF}$	
	High level voltage shutdown threshold (amplifier enabled)	$V_S = 1.8\text{ V to }5.5\text{ V}$		$(V-) + 0.9$	$(V-) + 1.1$	V	
	Low level voltage shutdown threshold (amplifier disabled)	$V_S = 1.8\text{ V to }5.5\text{ V}$	$(V-) + 0.2\text{ V}$	$(V-) + 0.7\text{ V}$		V	
$t_{\text{ON}}$	Amplifier enable time (full shutdown)	$V_S = 1.8\text{ V to }5.5\text{ V}$ , full shutdown; $G = 1$ , $V_{\text{OUT}} = 0.9 \times V_S / 2$ , $R_L$ connected to $V-$		70		$\mu\text{s}$	
	Amplifier enable time (partial shutdown)	$V_S = 1.8\text{ V to }5.5\text{ V}$ , partial shutdown; $G = 1$ , $V_{\text{OUT}} = 0.9 \times V_S / 2$ , $R_L$ connected to $V-$		50			
$t_{\text{OFF}}$	Amplifier disable time	$V_S = 1.8\text{ V to }5.5\text{ V}$ , $G = 1$ , $V_{\text{OUT}} = 0.1 \times V_S / 2$ , $R_L$ connected to $V-$		4		$\mu\text{s}$	
	$\overline{\text{SHDN}}$ pin input bias current (per pin)	$V_S = 1.8\text{ V to }5.5\text{ V}$ , $V+ \geq \overline{\text{SHDN}} \geq (V+) - 0.8\text{ V}$		40		nA	
		$V_S = 1.8\text{ V to }5.5\text{ V}$ , $V- \leq \overline{\text{SHDN}} \leq V- + 0.8\text{ V}$		150			

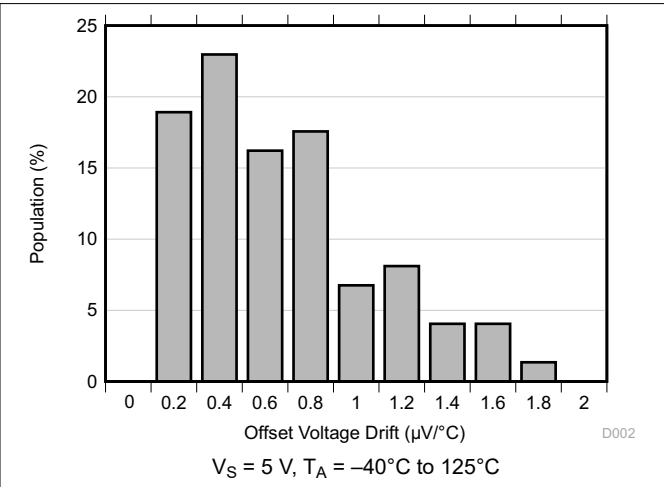
(1) Specified by design and characterization; not production tested.

### 7.11 Typical Characteristics

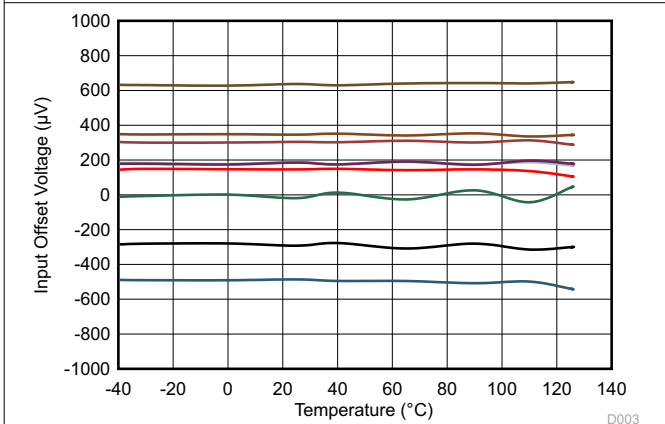
at  $T_A = 25^\circ\text{C}$ ,  $V_+ = 2.75\text{ V}$ ,  $V_- = -2.75\text{ V}$ ,  $R_L = 10\text{ k}\Omega$  connected to  $V_S / 2$ ,  $V_{CM} = V_S / 2$ , and  $V_{OUT} = V_S / 2$  (unless otherwise noted)



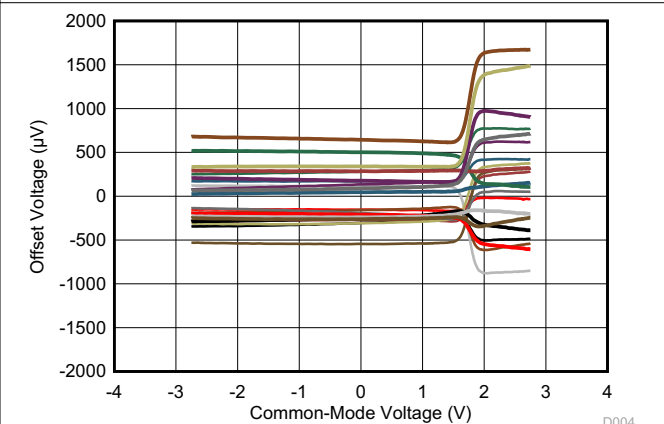
**Figure 7-1. Offset Voltage Distribution Histogram**



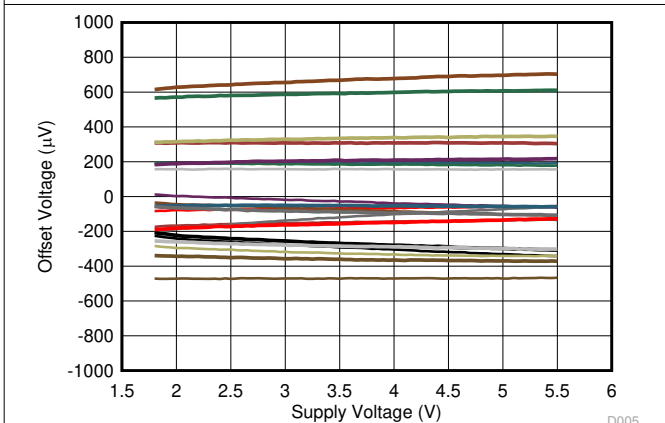
**Figure 7-2. Offset Voltage Drift Distribution Histogram**



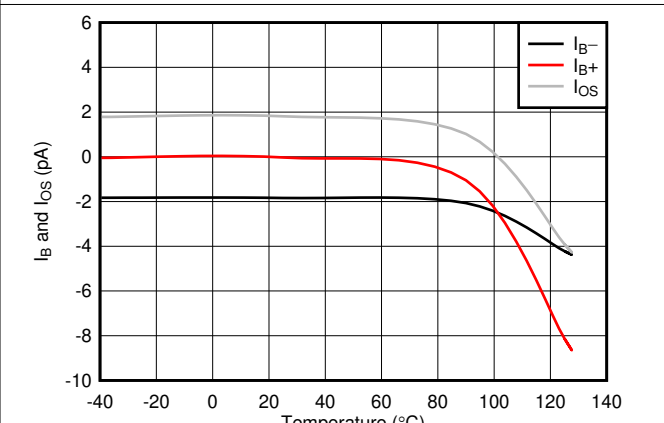
**Figure 7-3. Input Offset Voltage vs Temperature**



**Figure 7-4. Offset Voltage vs Common-Mode**



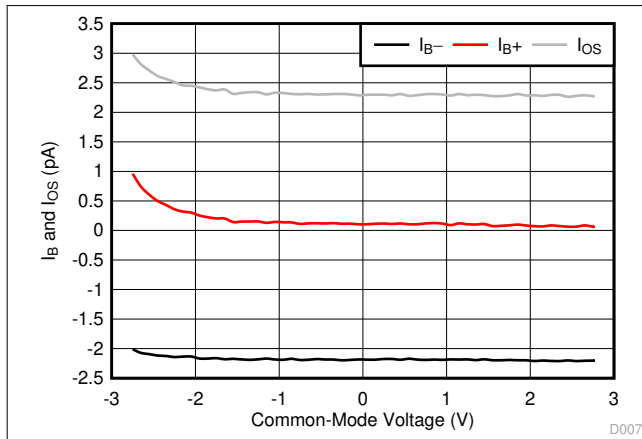
**Figure 7-5. Offset Voltage vs Supply Voltage**



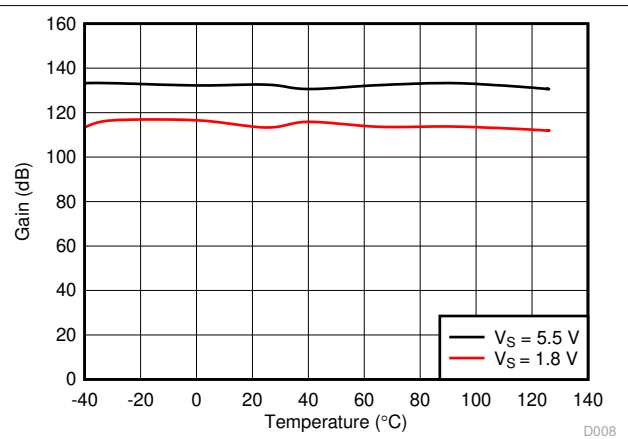
**Figure 7-6.  $I_B$  and  $I_{OS}$  vs Temperature**

### 7.11 Typical Characteristics (continued)

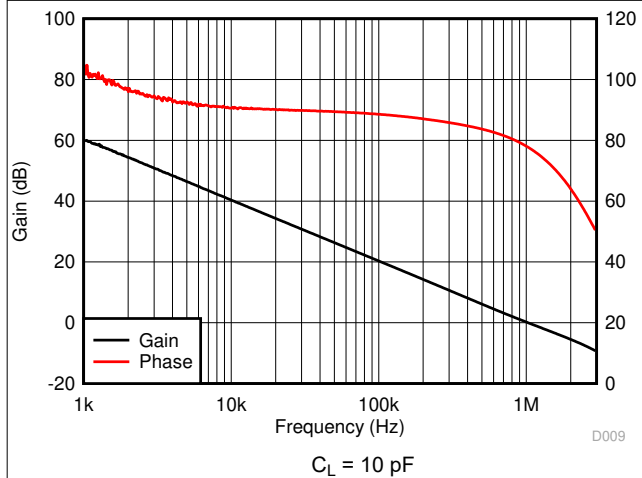
at  $T_A = 25^\circ\text{C}$ ,  $V_+ = 2.75\text{ V}$ ,  $V_- = -2.75\text{ V}$ ,  $R_L = 10\text{ k}\Omega$  connected to  $V_S / 2$ ,  $V_{CM} = V_S / 2$ , and  $V_{OUT} = V_S / 2$  (unless otherwise noted)



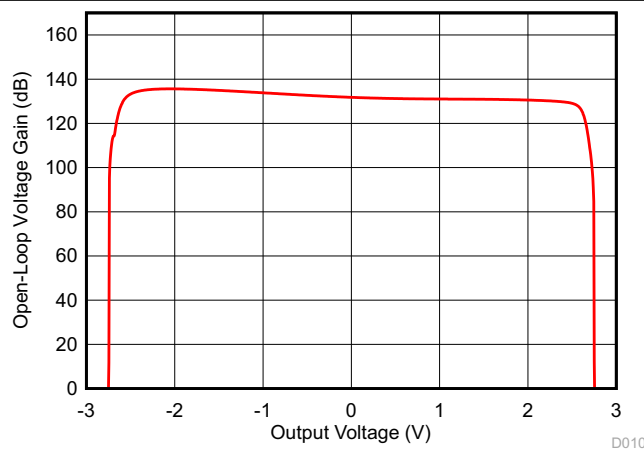
**Figure 7-7.  $I_B$  and  $I_{OS}$  vs Common-Mode Voltage**



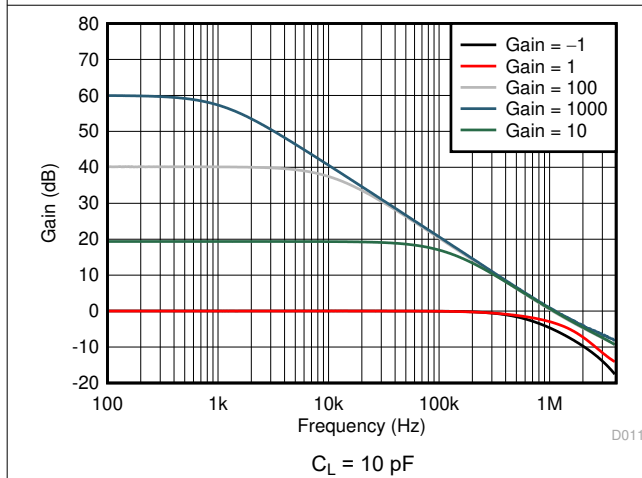
**Figure 7-8. Open-Loop Gain vs Temperature**



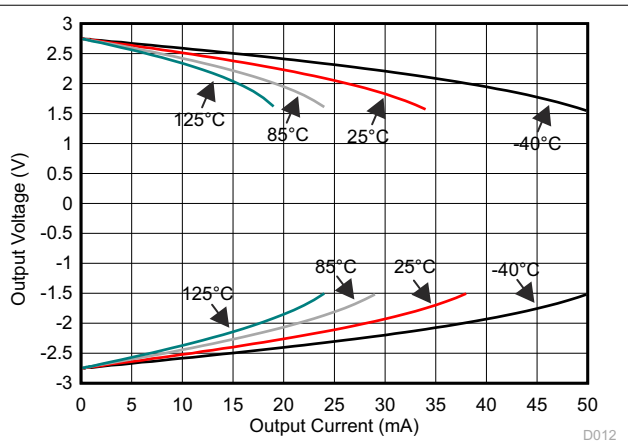
**Figure 7-9. Open-Loop Gain and Phase vs Frequency**



**Figure 7-10. Open-Loop Gain vs Output Voltage**



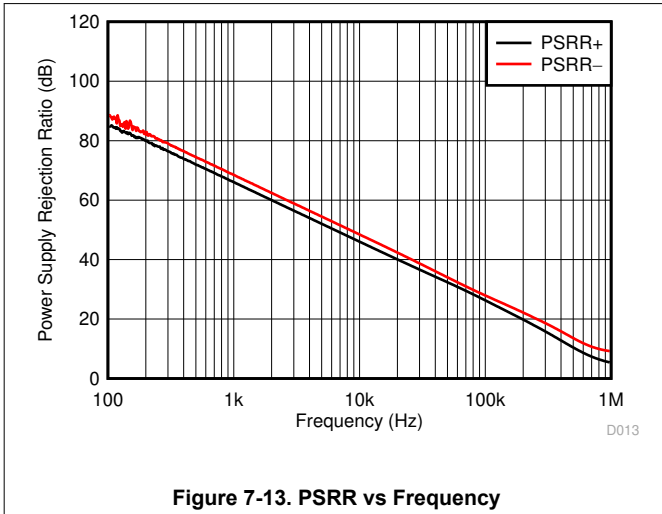
**Figure 7-11. Closed-Loop Gain vs Frequency**



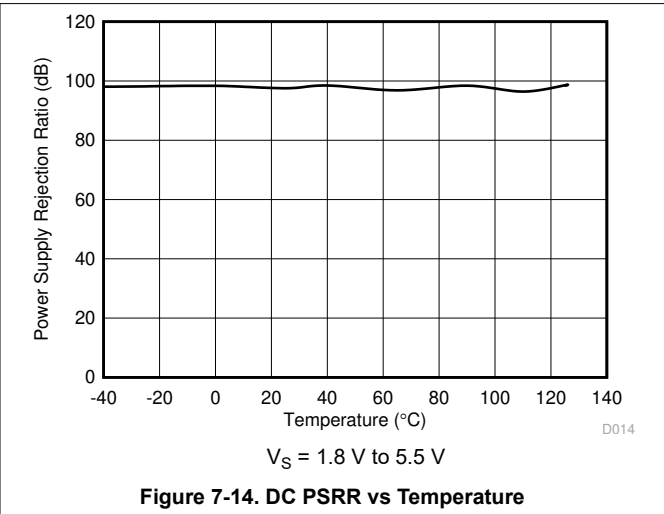
**Figure 7-12. Output Voltage vs Output Current (Claw)**

### 7.11 Typical Characteristics (continued)

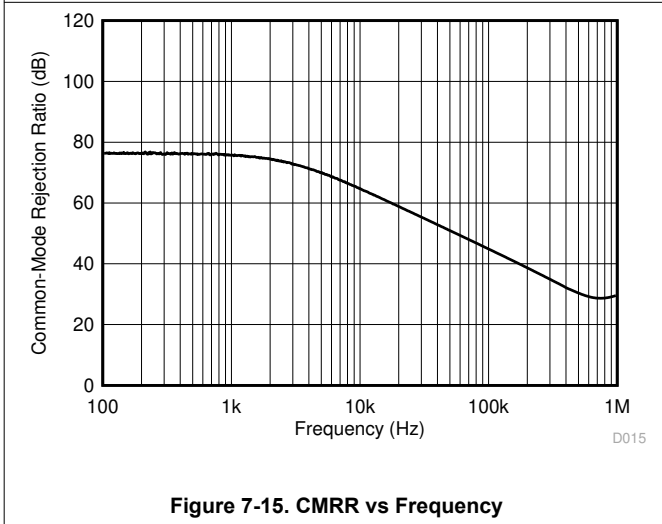
at  $T_A = 25^\circ\text{C}$ ,  $V_+ = 2.75\text{ V}$ ,  $V_- = -2.75\text{ V}$ ,  $R_L = 10\text{ k}\Omega$  connected to  $V_S / 2$ ,  $V_{CM} = V_S / 2$ , and  $V_{OUT} = V_S / 2$  (unless otherwise noted)



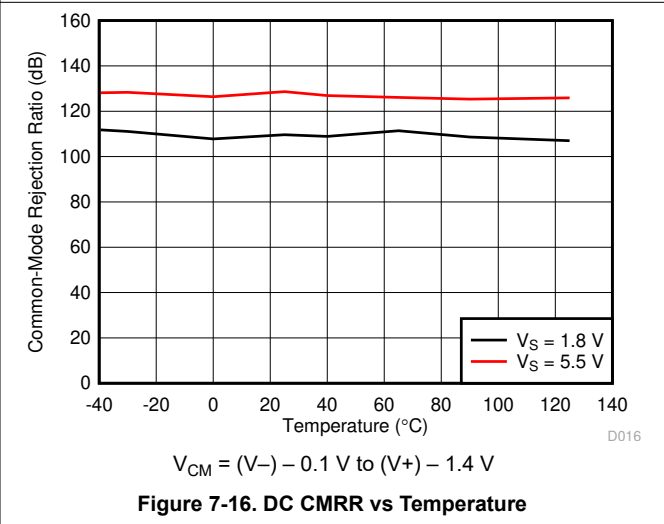
**Figure 7-13. PSRR vs Frequency**



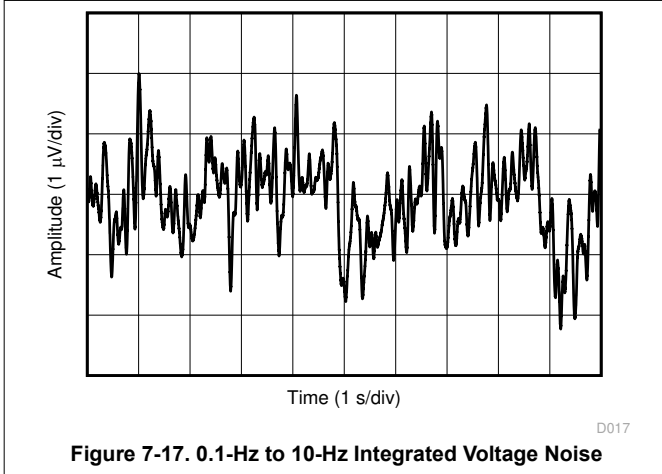
**Figure 7-14. DC PSRR vs Temperature**



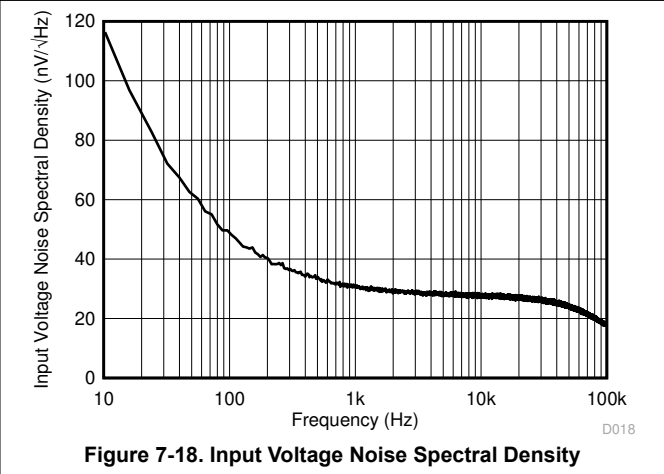
**Figure 7-15. CMRR vs Frequency**



**Figure 7-16. DC CMRR vs Temperature**



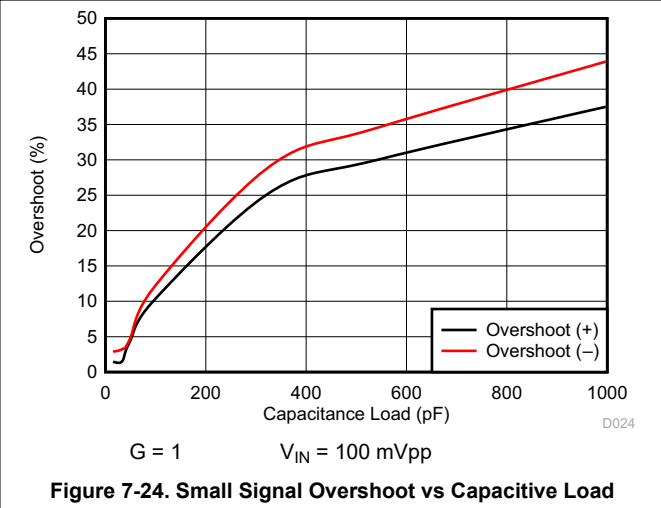
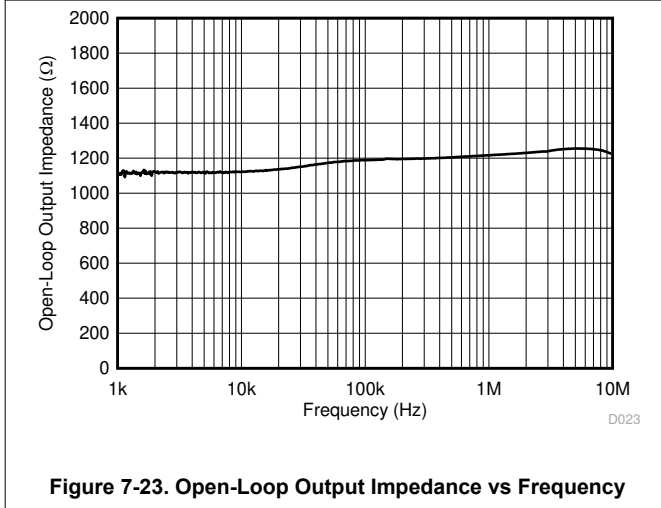
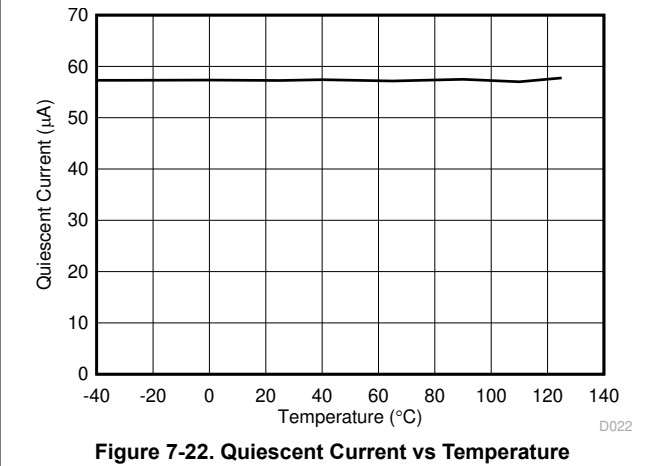
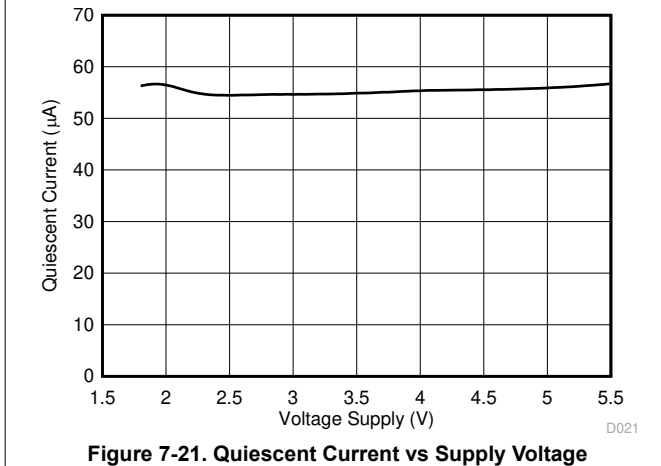
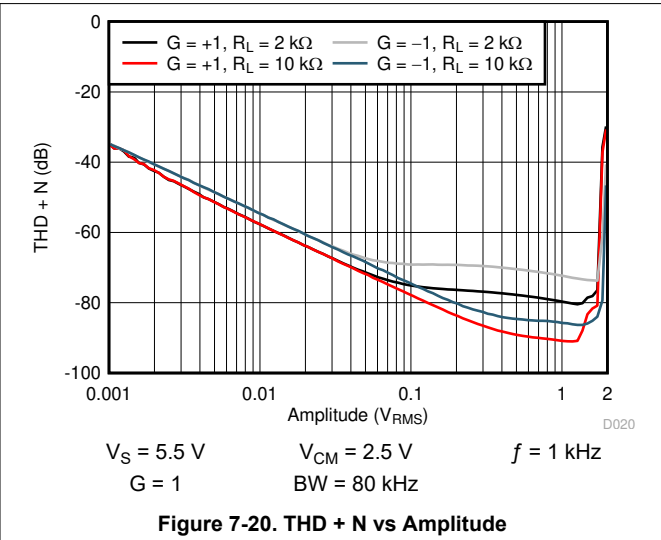
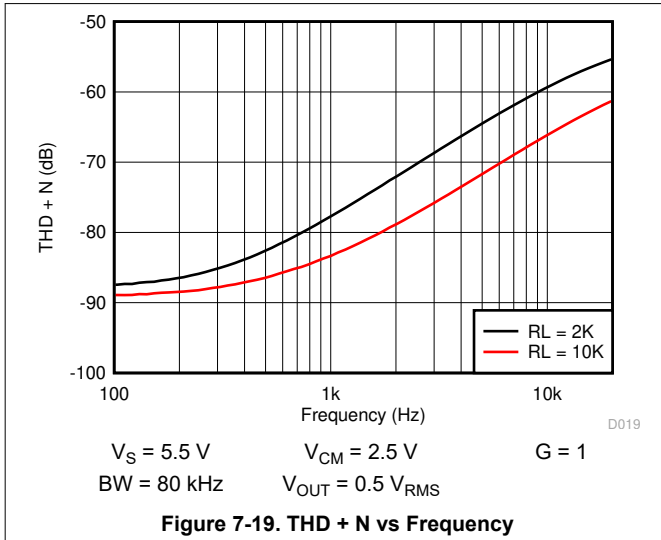
**Figure 7-17. 0.1-Hz to 10-Hz Integrated Voltage Noise**



**Figure 7-18. Input Voltage Noise Spectral Density**

### 7.11 Typical Characteristics (continued)

at  $T_A = 25^\circ\text{C}$ ,  $V_+ = 2.75\text{ V}$ ,  $V_- = -2.75\text{ V}$ ,  $R_L = 10\text{ k}\Omega$  connected to  $V_S / 2$ ,  $V_{CM} = V_S / 2$ , and  $V_{OUT} = V_S / 2$  (unless otherwise noted)



### 7.11 Typical Characteristics (continued)

at  $T_A = 25^\circ\text{C}$ ,  $V_+ = 2.75\text{ V}$ ,  $V_- = -2.75\text{ V}$ ,  $R_L = 10\text{ k}\Omega$  connected to  $V_S / 2$ ,  $V_{CM} = V_S / 2$ , and  $V_{OUT} = V_S / 2$  (unless otherwise noted)

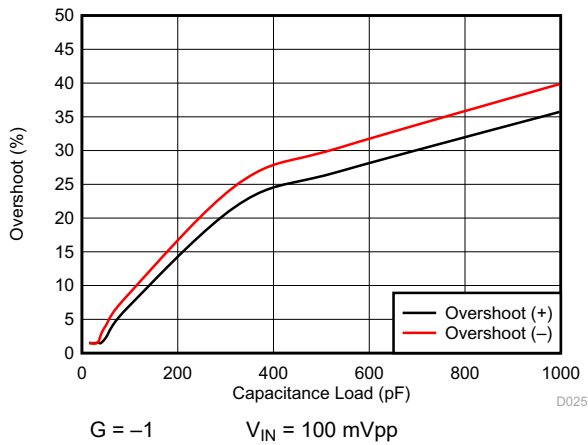


Figure 7-25. Small Signal Overshoot vs Capacitive Load

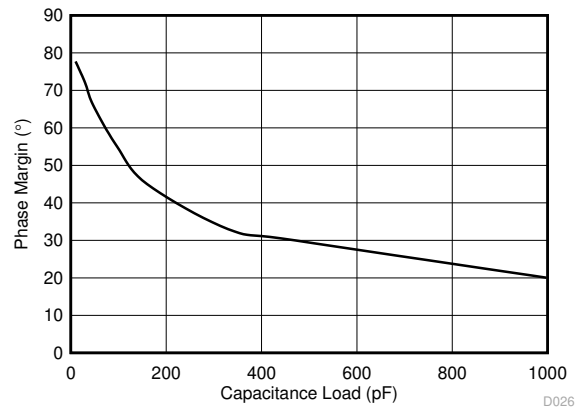


Figure 7-26. Phase Margin vs Capacitive Load

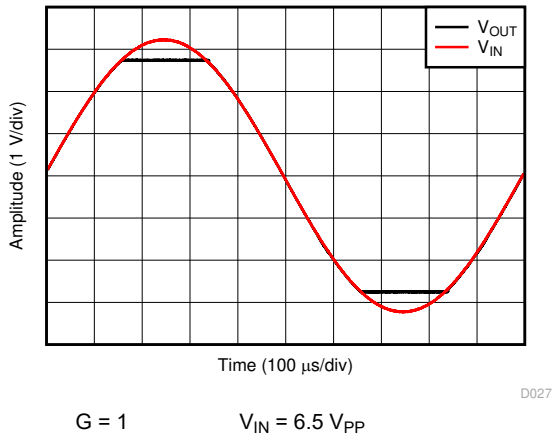


Figure 7-27. No Phase Reversal

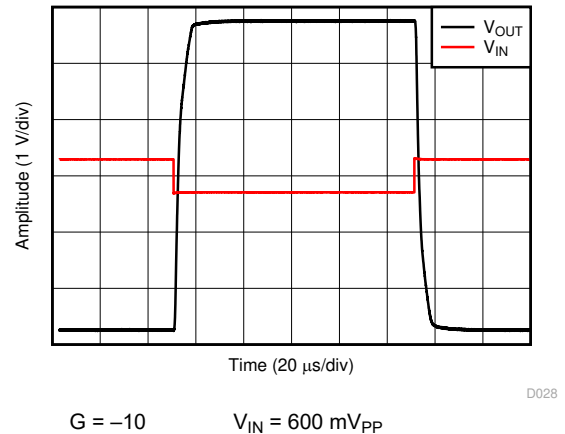


Figure 7-28. Overload Recovery

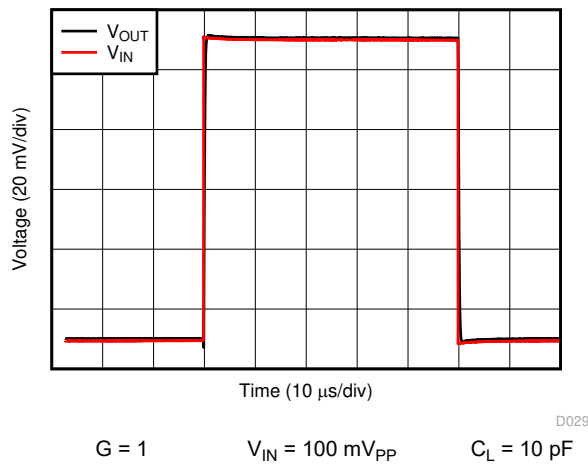


Figure 7-29. Small-Signal Step Response

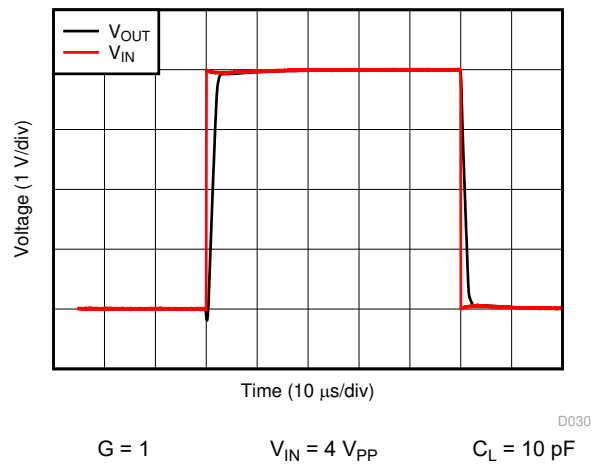
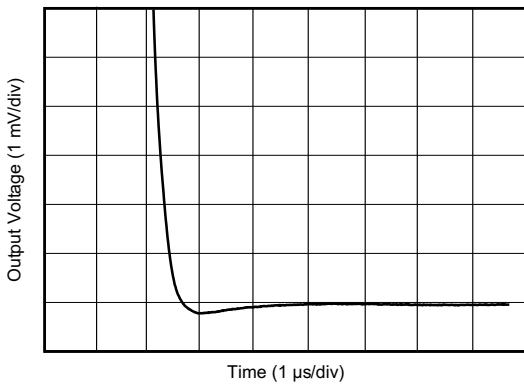


Figure 7-30. Large-Signal Step Response

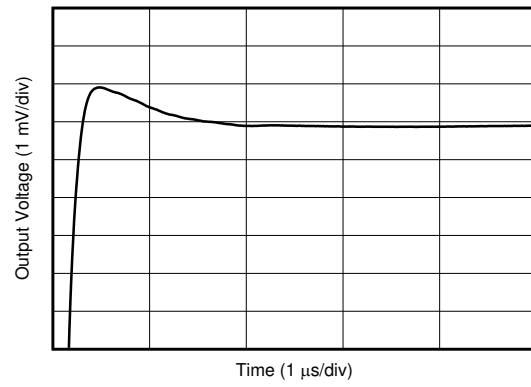
### 7.11 Typical Characteristics (continued)

at  $T_A = 25^\circ\text{C}$ ,  $V_+ = 2.75\text{ V}$ ,  $V_- = -2.75\text{ V}$ ,  $R_L = 10\text{ k}\Omega$  connected to  $V_S / 2$ ,  $V_{CM} = V_S / 2$ , and  $V_{OUT} = V_S / 2$  (unless otherwise noted)



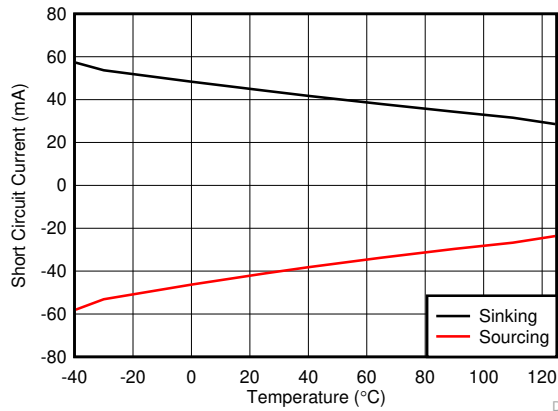
$G = 1$        $C_L = 100\text{ pF}$       2-V step

**Figure 7-31. Large-Signal Settling Time (Negative)**

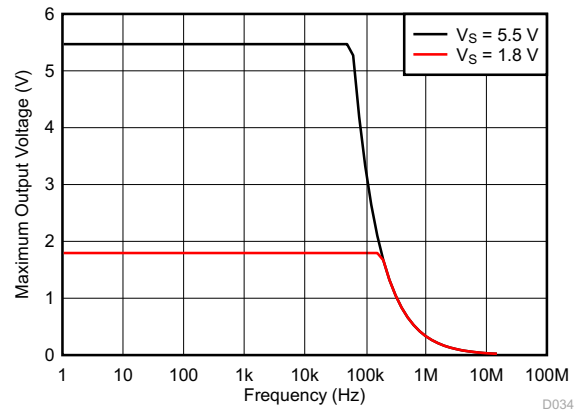


$G = 1$        $C_L = 100\text{ pF}$       2-V step

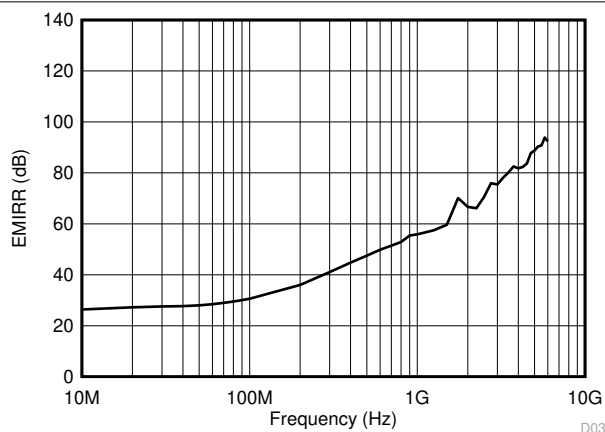
**Figure 7-32. Large-Signal Settling Time (Positive)**



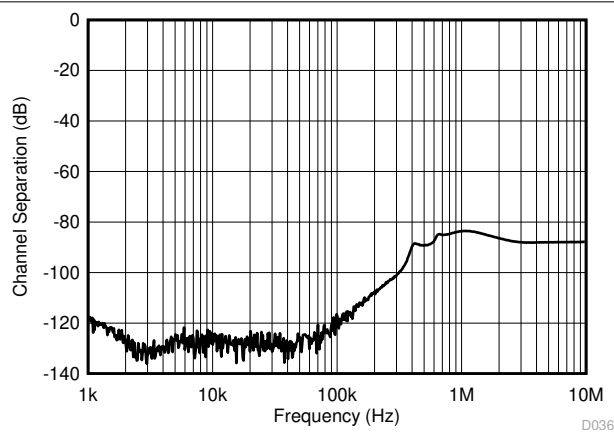
**Figure 7-33. Short-Circuit Current vs Temperature**



**Figure 7-34. Maximum Output Voltage vs Frequency**



**Figure 7-35. Electromagnetic Interference Rejection Ratio Referred to Noninverting Input (EMIRR+) vs Frequency**



**Figure 7-36. Channel Separation**

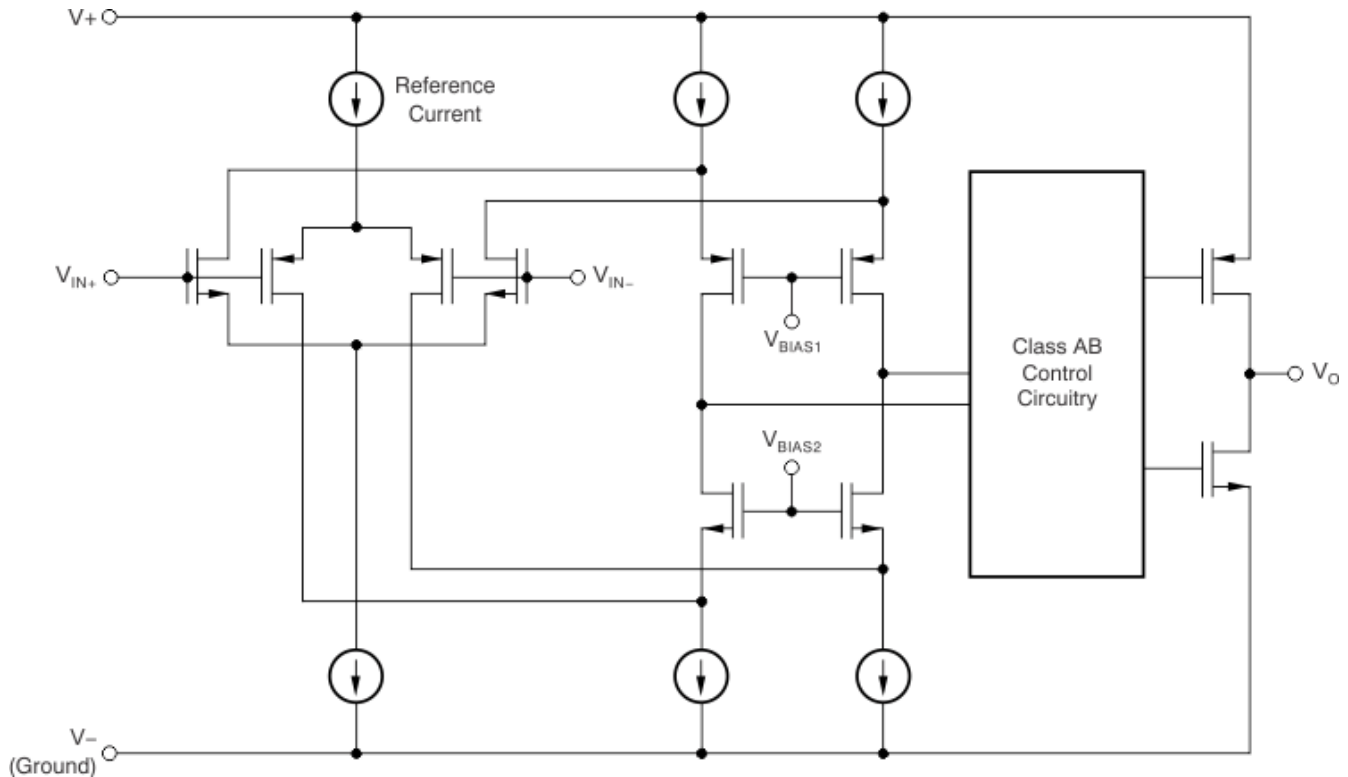


## 8 Detailed Description

### 8.1 Overview

The TLV900x is a family of low-power, rail-to-rail input and output op amps. These devices operate from 1.8 V to 5.5 V, are unity-gain stable, and are designed for a wide range of general-purpose applications. The input common-mode voltage range includes both rails and allows the TLV900x family to be used in virtually any single-supply application. Rail-to-rail input and output swing significantly increases dynamic range, especially in low-supply applications, and makes them suitable for driving sampling analog-to-digital converters (ADCs).

### 8.2 Functional Block Diagram



## 8.3 Feature Description

### 8.3.1 Operating Voltage

The TLV900x family of op amps are for operation from 1.8 V to 5.5 V. In addition, many specifications such as input offset voltage, quiescent current, offset current, and short circuit current apply from  $-40^{\circ}\text{C}$  to  $125^{\circ}\text{C}$ . Parameters that vary significantly with operating voltages or temperature are shown in [Section 7.11](#).

### 8.3.2 Rail-to-Rail Input

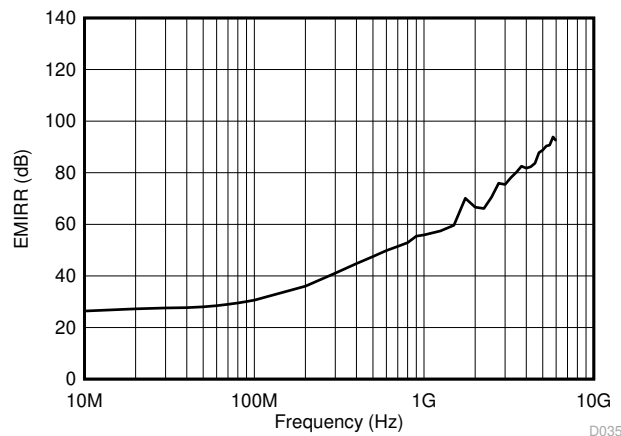
The input common-mode voltage range of the TLV900x family extends 100 mV beyond the supply rails for the full supply voltage range of 1.8 V to 5.5 V. This performance is achieved with a complementary input stage: an N-channel input differential pair in parallel with a P-channel differential pair, as shown in [Section 8.2](#). The N-channel pair is active for input voltages close to the positive rail, typically  $(V+) - 1.4\text{ V}$  to 100 mV above the positive supply, whereas the P-channel pair is active for inputs from 100 mV below the negative supply to approximately  $(V+) - 1.4\text{ V}$ . There is a small transition region, typically  $(V+) - 1.2\text{ V}$  to  $(V+) - 1\text{ V}$ , in which both pairs are on. This 100-mV transition region can vary up to 100 mV with process variation. Thus, the transition region (with both stages on) can range from  $(V+) - 1.4\text{ V}$  to  $(V+) - 1.2\text{ V}$  on the low end, and up to  $(V+) - 1\text{ V}$  to  $(V+) - 0.8\text{ V}$  on the high end. Within this transition region, PSRR, CMRR, offset voltage, offset drift, and THD can degrade compared to device operation outside this region.

### 8.3.3 Rail-to-Rail Output

Designed as a low-power, low-voltage operational amplifier, the TLV900x family delivers a robust output drive capability. A class-AB output stage with common-source transistors achieves full rail-to-rail output swing capability. For resistive loads of 10 k $\Omega$ , the output swings to within 20 mV of either supply rail, regardless of the applied power-supply voltage. Different load conditions change the ability of the amplifier to swing close to the rails.

### 8.3.4 EMI Rejection

The TLV900x uses integrated electromagnetic interference (EMI) filtering to reduce the effects of EMI from sources such as wireless communications and densely-populated boards with a mix of analog signal chain and digital components. EMI immunity can be improved with circuit design techniques; the TLV900x benefits from these design improvements. Texas Instruments has developed the ability to accurately measure and quantify the immunity of an operational amplifier over a broad frequency spectrum extending from 10 MHz to 6 GHz. [Figure 8-1](#) shows the results of this testing on the TLV900x. [Table 8-1](#) shows the EMIRR IN+ values for the TLV900x at particular frequencies commonly encountered in real-world applications. The [EMI Rejection Ratio of Operational Amplifiers](#) application report contains detailed information on the topic of EMIRR performance as it relates to op amps and is available for download from [www.ti.com](http://www.ti.com).



**Figure 8-1. EMIRR Testing**

**Table 8-1. TLV900x EMIRR IN+ For Frequencies of Interest**

FREQUENCY	APPLICATION OR ALLOCATION	EMIRR IN+
400 MHz	Mobile radio, mobile satellite, space operation, weather, radar, ultra-high frequency (UHF) applications	59.5 dB
900 MHz	Global system for mobile communications (GSM) applications, radio communication, navigation, GPS (to 1.6 GHz), GSM, aeronautical mobile, UHF applications	68.9 dB
1.8 GHz	GSM applications, mobile personal communications, broadband, satellite, L-band (1 GHz to 2 GHz)	77.8 dB
2.4 GHz	802.11b, 802.11g, 802.11n, Bluetooth®, mobile personal communications, industrial, scientific and medical (ISM) radio band, amateur radio and satellite, S-band (2 GHz to 4 GHz)	78.0 dB
3.6 GHz	Radiolocation, aero communication and navigation, satellite, mobile, S-band	88.8 dB

## 8.4 Overload Recovery

Overload recovery is defined as the time required for the operational amplifier output to recover from a saturated state to a linear state. The output devices of the operational amplifier enter a saturation region when the output voltage exceeds the rated operating voltage, because of the high input voltage or the high gain. After the device enters the saturation region, the charge carriers in the output devices require time to return to the linear state. After the charge carriers return to the linear state, the device begins to slew at the specified slew rate. Therefore, the propagation delay (in case of an overload condition) is the sum of the overload recovery time and the slew time. The overload recovery time for the TLV900x family is approximately 850 ns.

## 8.5 Shutdown

The TLV9001S, TLV9002S, and TLV9004S devices feature  $\overline{\text{SHDN}}$  pins that disable the op amp, placing it into a low-power standby mode. In this mode, the op amp typically consumes less than 1  $\mu\text{A}$ . The  $\overline{\text{SHDN}}$  pins are active low, meaning that shutdown mode is enabled when the input to the  $\overline{\text{SHDN}}$  pin is a valid logic low.

The  $\overline{\text{SHDN}}$  pins are referenced to the negative supply voltage of the op amp. The threshold of the shutdown feature lies around 620 mV (typical) and does not change with respect to the supply voltage. Hysteresis has been included in the switching threshold to ensure smooth switching characteristics. To ensure optimal shutdown behavior, the  $\overline{\text{SHDN}}$  pins should be driven with valid logic signals. A valid logic low is defined as a voltage between  $V_-$  and  $V_- + 0.2\text{ V}$ . A valid logic high is defined as a voltage between  $V_- + 1.2\text{ V}$  and  $V_+$ . The shutdown pin circuitry includes a pull-up resistor, which will inherently pull the voltage of the pin to the positive supply rail if not driven. Thus, to enable the amplifier, the  $\overline{\text{SHDN}}$  pins should either be left floating or driven to a valid logic high. To disable the amplifier, the  $\overline{\text{SHDN}}$  pins must be driven to a valid logic low. While we highly recommend that the shutdown pin be connected to a valid high or a low voltage or driven, we have included a pull-up resistor connected to VCC. The maximum voltage allowed at the  $\overline{\text{SHDN}}$  pins is  $(V_+) + 0.5\text{ V}$ . Exceeding this voltage level will damage the device.

The  $\overline{\text{SHDN}}$  pins are high-impedance CMOS inputs. Dual op amp versions are independently controlled and quad op amp versions are controlled in pairs with logic inputs. For battery-operated applications, this feature may be used to greatly reduce the average current and extend battery life. The enable time is 70  $\mu\text{s}$  for full shutdown of all channels; disable time is 4  $\mu\text{s}$ . When disabled, the output assumes a high-impedance state. This architecture allows the TLV9002S and TLV9004S to operate as a gated amplifier (or to have the device output multiplexed onto a common analog output bus). Shutdown time ( $t_{\text{OFF}}$ ) depends on loading conditions and increases as load resistance increases. To ensure shutdown (disable) within a specific shutdown time, the specified 10-k $\Omega$  load to midsupply ( $V_S / 2$ ) is required. If using the TLV9001S, TLV9002S, or TLV9004S without a load, the resulting turnoff time significantly increases.

## 8.6 Device Functional Modes

The TLV900x family has a single functional mode. The devices are powered on as long as the power-supply voltage is between 1.8 V ( $\pm 0.9\text{ V}$ ) and 5.5 V ( $\pm 2.75\text{ V}$ ).

## 9 Application and Implementation

### Note

Information in the following applications sections is not part of the TI component specification, and TI does not warrant its accuracy or completeness. TI's customers are responsible for determining suitability of components for their purposes. Customers should validate and test their design implementation to confirm system functionality.

### 9.1 Application Information

The TLV900x family of low-power, rail-to-rail input and output operational amplifiers is specifically designed for portable applications. The devices operate from 1.8 V to 5.5 V, are unity-gain stable, and are suitable for a wide range of general-purpose applications. The class AB output stage is capable of driving less than or equal to 10-k $\Omega$  loads connected to any point between V+ and V-. The input common-mode voltage range includes both rails, and allows the TLV900x devices to be used in any single-supply application.

### 9.2 Typical Application

#### 9.2.1 TLV900x Low-Side, Current Sensing Application

Figure 9-1 shows the TLV900x configured in a low-side current sensing application.

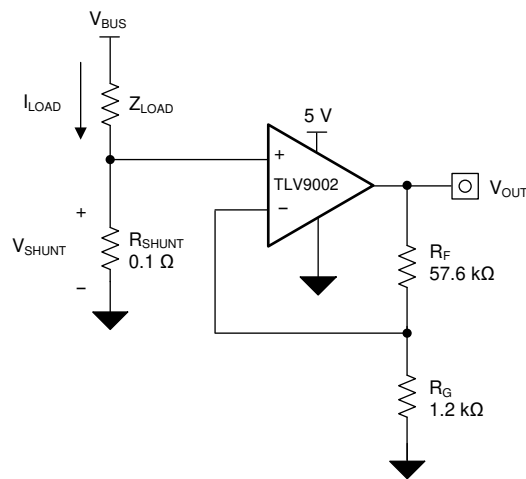


Figure 9-1. TLV900x in a Low-Side, Current-Sensing Application

### 9.2.1.1 Design Requirements

The design requirements for this design are:

- Load current: 0 A to 1 A
- Output voltage: 4.9 V
- Maximum shunt voltage: 100 mV

### 9.2.1.2 Detailed Design Procedure

The transfer function of the circuit in [Figure 9-1](#) is given in [Equation 1](#).

$$V_{OUT} = I_{LOAD} \times R_{SHUNT} \times \text{Gain} \quad (1)$$

The load current ( $I_{LOAD}$ ) produces a voltage drop across the shunt resistor ( $R_{SHUNT}$ ). The load current is set from 0 A to 1 A. To keep the shunt voltage below 100 mV at maximum load current, the largest shunt resistor is shown using [Equation 2](#).

$$R_{SHUNT} = \frac{V_{SHUNT\_MAX}}{I_{LOAD\_MAX}} = \frac{100\text{mV}}{1\text{A}} = 100\text{m}\Omega \quad (2)$$

Using [Equation 2](#),  $R_{SHUNT}$  is calculated to be 100 m $\Omega$ . The voltage drop produced by  $I_{LOAD}$  and  $R_{SHUNT}$  is amplified by the TLV900x to produce an output voltage of approximately 0 V to 4.9 V. The gain needed by the TLV900x to produce the necessary output voltage is calculated using [Equation 3](#).

$$\text{Gain} = \frac{(V_{OUT\_MAX} - V_{OUT\_MIN})}{(V_{IN\_MAX} - V_{IN\_MIN})} \quad (3)$$

Using [Equation 3](#), the required gain is calculated to be 49 V/V, which is set with resistors  $R_F$  and  $R_G$ . [Equation 4](#) sizes the resistors  $R_F$  and  $R_G$ , to set the gain of the TLV900x to 49 V/V.

$$\text{Gain} = 1 + \frac{(R_F)}{(R_G)} \quad (4)$$

Selecting  $R_F$  as 57.6 k $\Omega$  and  $R_G$  as 1.2 k $\Omega$  provides a combination that equals 49 V/V. [Figure 9-2](#) shows the measured transfer function of the circuit shown in [Figure 9-1](#). Notice that the gain is only a function of the feedback and gain resistors. This gain is adjusted by varying the ratio of the resistors and the actual resistors values are determined by the impedance levels that the designer wants to establish. The impedance level determines the current drain, the effect that stray capacitance has, and a few other behaviors. There is no optimal impedance selection that works for every system, you must choose an impedance that is ideal for your system parameters.

### 9.2.1.3 Application Curve

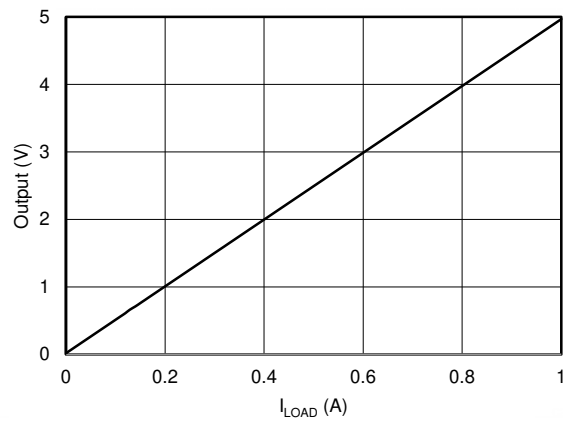
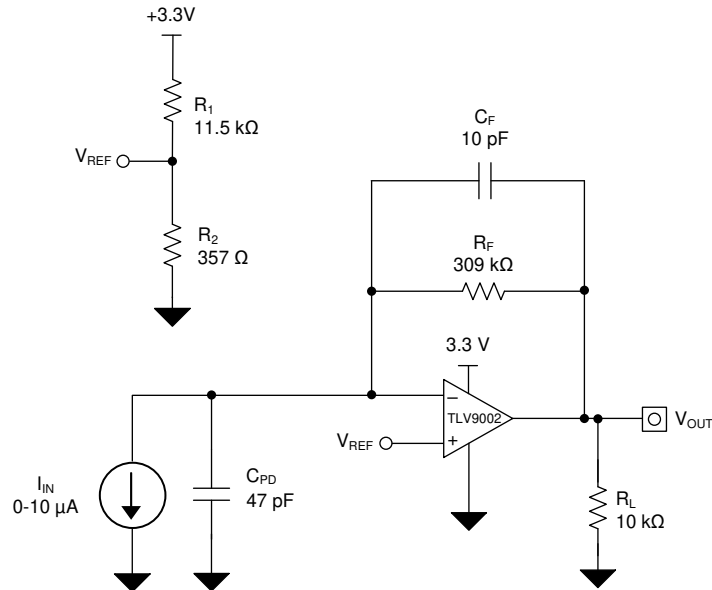


Figure 9-2. Low-Side, Current-Sense Transfer Function

### 9.2.2 Single-Supply Photodiode Amplifier

Photodiodes are used in many applications to convert light signals to electrical signals. The current through the photodiode is proportional to the photon energy absorbed, and is commonly in the range of a few hundred picoamps to a few tens of microamps. An amplifier in a transimpedance configuration is typically used to convert the low-level photodiode current to a voltage signal for processing in an MCU. The circuit shown in Figure 9-3 is an example of a single-supply photodiode amplifier circuit using the TLV9002.



**Figure 9-3. Single-Supply Photodiode Amplifier Circuit**

### 9.2.2.1 Design Requirements

The design requirements for this design are:

- Supply voltage: 3.3 V
- Input: 0  $\mu$ A to 10  $\mu$ A
- Output: 0.1 V to 3.2 V
- Bandwidth: 50 kHz

### 9.2.2.2 Detailed Design Procedure

The transfer function between the output voltage ( $V_{OUT}$ ), the input current, ( $I_{IN}$ ) and the reference voltage ( $V_{REF}$ ) is defined in [Equation 5](#).

$$V_{OUT} = I_{IN} \times R_F + V_{REF} \quad (5)$$

Where:

$$V_{REF} = V_+ \times \left( \frac{R_1 \times R_2}{R_1 + R_2} \right) \quad (6)$$

Set  $V_{REF}$  to 100 mV to meet the minimum output voltage level by setting R1 and R2 to meet the required ratio calculated in [Equation 7](#).

$$\frac{V_{REF}}{V_+} = \frac{0.1 \text{ V}}{3.3 \text{ V}} = 0.0303 \quad (7)$$

The closest resistor ratio to meet this ratio sets R1 to 11.5 k $\Omega$  and R2 to 357  $\Omega$ .

The required feedback resistance can be calculated based on the input current and desired output voltage.

$$R_F = \frac{V_{OUT} - V_{REF}}{I_{IN}} = \frac{3.2 \text{ V} - 0.1 \text{ V}}{10 \mu\text{A}} = 310 \frac{\text{kV}}{\text{A}} \approx 309 \text{ k}\Omega \quad (8)$$

Calculate the value for the feedback capacitor based on  $R_F$  and the desired –3-dB bandwidth, ( $f_{-3dB}$ ) using [Equation 9](#).

$$C_F = \frac{1}{2 \times \pi \times R_F \times f_{-3dB}} = \frac{1}{2 \times \pi \times 309 \text{ k}\Omega \times 50 \text{ kHz}} = 10.3 \text{ pF} \approx 10 \text{ pF} \quad (9)$$

The minimum op amp bandwidth required for this application is based on the value of  $R_F$ ,  $C_F$ , and the capacitance on the INx– pin of the TLV9002 which is equal to the sum of the photodiode shunt capacitance, (CPD) the common-mode input capacitance, (CCM) and the differential input capacitance (CD) as [Equation 10](#) shows.

$$C_{IN} = C_{PD} + C_{CM} + C_D = 47 \text{ pF} + 5 \text{ pF} + 1 \text{ pF} = 53 \text{ pF} \quad (10)$$

The minimum op amp bandwidth is calculated in [Equation 11](#).

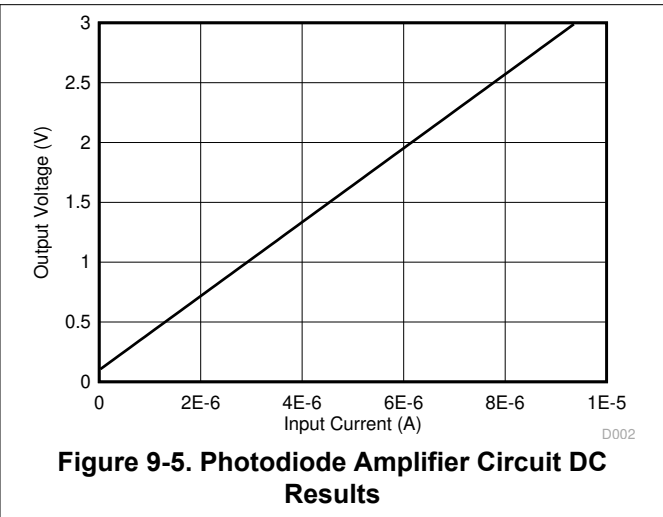
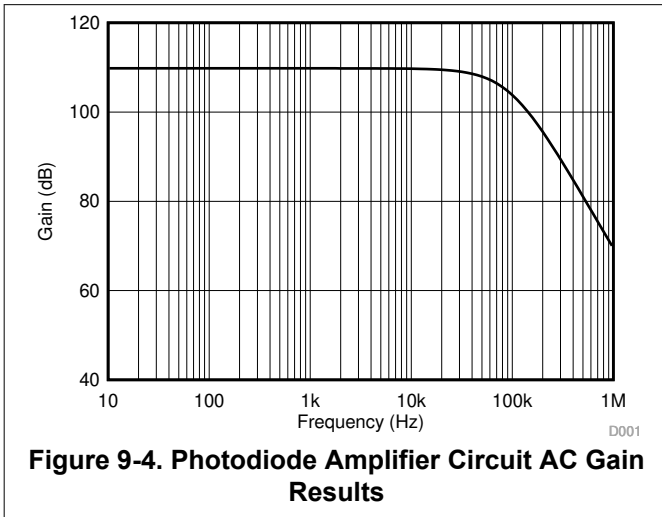
$$f_{-BGW} \geq \frac{C_{IN} + C_F}{2 \times \pi \times R_F \times C_F^2} \geq 324 \text{ kHz} \quad (11)$$

The 1-MHz bandwidth of the TLV900x meets the minimum bandwidth requirement and remains stable in this application configuration.



### 9.2.2.3 Application Curves

The measured current-to-voltage transfer function for the photodiode amplifier circuit is shown in Figure 9-4. The measured performance of the photodiode amplifier circuit is shown in Figure 9-5.



## 10 Power Supply Recommendations

The TLV900x family is specified for operation from 1.8 V to 5.5 V ( $\pm 0.9$  V to  $\pm 2.75$  V); many specifications apply from  $-40^{\circ}\text{C}$  to  $125^{\circ}\text{C}$ . [Section 7.11](#) presents parameters that may exhibit significant variance with regard to operating voltage or temperature.

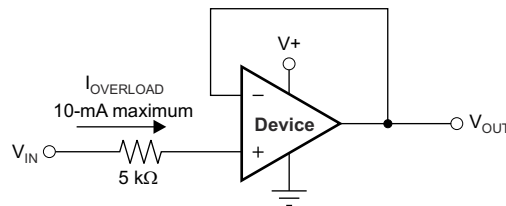
### CAUTION

Supply voltages larger than 6 V may permanently damage the device; see [Section 7.1](#).

Place 0.1- $\mu\text{F}$  bypass capacitors close to the power-supply pins to reduce coupling errors from noisy or high-impedance power supplies. For more detailed information on bypass capacitor placement, see [Section 11.1](#).

### 10.1 Input and ESD Protection

The TLV900x family incorporates internal ESD protection circuits on all pins. For input and output pins, this protection primarily consists of current-steering diodes connected between the input and power-supply pins. These ESD protection diodes provide in-circuit, input overdrive protection, as long as the current is limited to 10 mA. [Figure 10-1](#) shows how a series input resistor can be added to the driven input to limit the input current. The added resistor contributes thermal noise at the amplifier input and the value must be kept to a minimum in noise-sensitive applications.



**Figure 10-1. Input Current Protection**

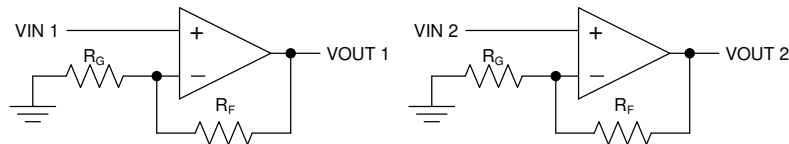
## 11 Layout

### 11.1 Layout Guidelines

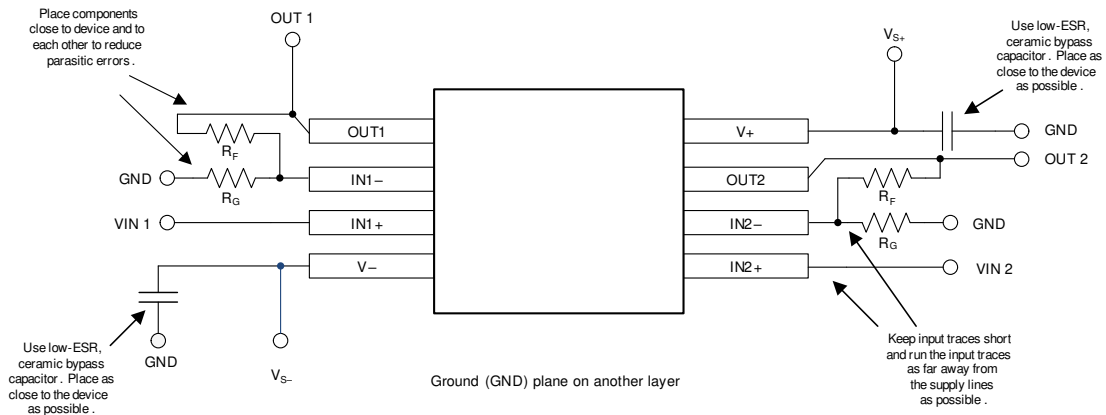
For best operational performance of the device, use good printed circuit board (PCB) layout practices, including:

- Noise can propagate into analog circuitry through the power connections of the board and propagate to the power pins of the op amp itself. Bypass capacitors are used to reduce the coupled noise by providing a low-impedance path to ground.
  - Connect low-ESR, 0.1- $\mu\text{F}$  ceramic bypass capacitors between each supply pin and ground, placed as close to the device as possible. A single bypass capacitor from  $V_+$  to ground is adequate for single-supply applications.
- Separate grounding for analog and digital portions of circuitry is one of the simplest and most effective methods of noise suppression. One or more layers on multilayer PCBs are usually devoted to ground planes. A ground plane helps distribute heat and reduces electromagnetic interference (EMI) noise pickup. Take care to physically separate digital and analog grounds, paying attention to the flow of the ground current.
- To reduce parasitic coupling, run the input traces as far away from the supply or output traces as possible. If these traces cannot be kept separate, crossing the sensitive trace at a 90 degree angle is much better as opposed to running the traces in parallel with the noisy trace.
- Place the external components as close to the device as possible, as shown in Figure 11-2. Keeping  $R_F$  and  $R_G$  close to the inverting input minimizes parasitic capacitance.
- Keep the length of input traces as short as possible. Remember that the input traces are the most sensitive part of the circuit.
- Consider a driven, low-impedance guard ring around the critical traces. A guard ring may significantly reduce leakage currents from nearby traces that are at different potentials.
- Cleaning the PCB following board assembly is recommended for best performance.
- Any precision integrated circuit can experience performance shifts resulting from moisture ingress into the plastic package. Following any aqueous PCB cleaning process, baking the PCB assembly is recommended to remove moisture introduced into the device packaging during the cleaning process. A low-temperature, post-cleaning bake at 85°C for 30 minutes is sufficient for most circumstances.

### 11.2 Layout Example



**Figure 11-1. Schematic Representation**



**Figure 11-2. Layout Example**

## 12 Device and Documentation Support

### 12.1 Documentation Support

#### 12.1.1 Related Documentation

For related documentation, see the following:

- Texas Instruments, [EMI Rejection Ratio of Operational Amplifiers](#)

### 12.2 Receiving Notification of Documentation Updates

To receive notification of documentation updates, navigate to the device product folder on [ti.com](#). Click on *Subscribe to updates* to register and receive a weekly digest of any product information that has changed. For change details, review the revision history included in any revised document.

### 12.3 Support Resources

[TI E2E™ support forums](#) are an engineer's go-to source for fast, verified answers and design help — straight from the experts. Search existing answers or ask your own question to get the quick design help you need.

Linked content is provided "AS IS" by the respective contributors. They do not constitute TI specifications and do not necessarily reflect TI's views; see TI's [Terms of Use](#).

### 12.4 Trademarks

TI E2E™ is a trademark of Texas Instruments.

Bluetooth® is a registered trademark of Bluetooth SIG, Inc.

All trademarks are the property of their respective owners.

### 12.5 Electrostatic Discharge Caution



This integrated circuit can be damaged by ESD. Texas Instruments recommends that all integrated circuits be handled with appropriate precautions. Failure to observe proper handling and installation procedures can cause damage.

ESD damage can range from subtle performance degradation to complete device failure. Precision integrated circuits may be more susceptible to damage because very small parametric changes could cause the device not to meet its published specifications.

### 12.6 Glossary

[TI Glossary](#) This glossary lists and explains terms, acronyms, and definitions.

## 13 Mechanical, Packaging, and Orderable Information

The following pages include mechanical, packaging, and orderable information. This information is the most-current data available for the designated devices. This data is subject to change without notice and without revision of this document. For browser-based versions of this data sheet, see the left-hand navigation pane.

**PACKAGING INFORMATION**

Orderable Device	Status (1)	Package Type	Package Drawing	Pins	Package Qty	Eco Plan (2)	Lead finish/ Ball material (6)	MSL Peak Temp (3)	Op Temp (°C)	Device Marking (4/5)	Samples
TLV9001IDBVR	ACTIVE	SOT-23	DBV	5	3000	RoHS & Green	NIPDAU   SN	Level-1-260C-UNLIM	-40 to 125	1OGF	<a href="#">Samples</a>
TLV9001IDCKR	ACTIVE	SC70	DCK	5	3000	RoHS & Green	SN	Level-2-260C-1 YEAR	-40 to 125	1BZ	<a href="#">Samples</a>
TLV9001IDPWR	ACTIVE	X2SON	DPW	5	3000	RoHS & Green	NIPDAUAG	Level-2-260C-1 YEAR	-40 to 125	DF	<a href="#">Samples</a>
TLV9001SIDBVR	ACTIVE	SOT-23	DBV	6	3000	RoHS & Green	NIPDAU   SN	Level-1-260C-UNLIM	-40 to 125	1OJF	<a href="#">Samples</a>
TLV9001SIDCKR	ACTIVE	SC70	DCK	6	3000	RoHS & Green	SN	Level-2-260C-1 YEAR	-40 to 125	1F8	<a href="#">Samples</a>
TLV9001TIDCKR	ACTIVE	SC70	DCK	5	3000	RoHS & Green	SN	Level-2-260C-1 YEAR	-40 to 125	1D6	<a href="#">Samples</a>
TLV9001UIDBVR	ACTIVE	SOT-23	DBV	5	3000	RoHS & Green	NIPDAU   SN	Level-1-260C-UNLIM	-40 to 125	1ODF	<a href="#">Samples</a>
TLV9001ZIDPWR	ACTIVE	X2SON	DPW	5	3000	RoHS & Green	NIPDAU   NIPDAUAG	Level-1-260C-UNLIM	-40 to 125	(D, DF)	<a href="#">Samples</a>
TLV9002IDDFR	ACTIVE	SOT-23-THIN	DDF	8	3000	RoHS & Green	NIPDAU	Level-1-260C-UNLIM	-40 to 125	T902	<a href="#">Samples</a>
TLV9002IDGKR	ACTIVE	VSSOP	DGK	8	2500	RoHS & Green	NIPDAU   NIPDAUAG   SN	Level-2-260C-1 YEAR	-40 to 125	(1GNX, OBBI)	<a href="#">Samples</a>
TLV9002IDGKT	ACTIVE	VSSOP	DGK	8	250	RoHS & Green	NIPDAU   NIPDAUAG   SN	Level-2-260C-1 YEAR	-40 to 125	(1GNX, OBBI)	<a href="#">Samples</a>
TLV9002IDR	ACTIVE	SOIC	D	8	2500	RoHS & Green	NIPDAU	Level-1-260C-UNLIM	-40 to 125	TL9002	<a href="#">Samples</a>
TLV9002IDSGR	ACTIVE	WSO	DSG	8	3000	RoHS & Green	NIPDAU	Level-1-260C-UNLIM	-40 to 125	1GMH	<a href="#">Samples</a>
TLV9002IDSGT	ACTIVE	WSO	DSG	8	250	RoHS & Green	NIPDAU	Level-1-260C-UNLIM	-40 to 125	1GMH	<a href="#">Samples</a>
TLV9002IPWR	ACTIVE	TSSOP	PW	8	2000	RoHS & Green	NIPDAU   SN	Level-2-260C-1 YEAR	-40 to 125	9002	<a href="#">Samples</a>
TLV9002SIDGSR	ACTIVE	VSSOP	DGS	10	2500	RoHS & Green	NIPDAUAG	Level-2-260C-1 YEAR	-40 to 125	1GDY	<a href="#">Samples</a>
TLV9002SIRUGR	ACTIVE	X2QFN	RUG	10	3000	RoHS & Green	NIPDAUAG	Level-2-260C-1 YEAR	-40 to 125	ENF	<a href="#">Samples</a>
TLV9002SIYCKR	ACTIVE	DSBGA	YCK	9	3000	RoHS & Green	SNAGCU	Level-1-260C-UNLIM	-40 to 125	JK	<a href="#">Samples</a>
TLV9004IDR	ACTIVE	SOIC	D	14	2500	RoHS & Green	NIPDAU	Level-2-260C-1 YEAR	-40 to 125	TLV9004	<a href="#">Samples</a>

Orderable Device	Status (1)	Package Type	Package Drawing	Pins	Package Qty	Eco Plan (2)	Lead finish/ Ball material (6)	MSL Peak Temp (3)	Op Temp (°C)	Device Marking (4/5)	Samples
TLV9004IDYYR	ACTIVE	SOT-23-THIN	DYY	14	3000	RoHS & Green	NIPDAU	Level-1-260C-UNLIM	-40 to 125	TLV9004I	<a href="#">Samples</a>
TLV9004IPWR	ACTIVE	TSSOP	PW	14	2000	RoHS & Green	NIPDAU   SN	Level-2-260C-1 YEAR	-40 to 125	TLV9004	<a href="#">Samples</a>
TLV9004IRTER	ACTIVE	WQFN	RTE	16	3000	RoHS & Green	NIPDAU	Level-1-260C-UNLIM	-40 to 125	T9004	<a href="#">Samples</a>
TLV9004IRUCR	ACTIVE	QFN	RUC	14	3000	RoHS & Green	NIPDAU	Level-2-260C-1 YEAR	-40 to 125	1DC	<a href="#">Samples</a>
TLV9004SIRTER	ACTIVE	WQFN	RTE	16	3000	RoHS & Green	NIPDAU	Level-1-260C-UNLIM	-40 to 125	T9004S	<a href="#">Samples</a>

(1) The marketing status values are defined as follows:

**ACTIVE:** Product device recommended for new designs.

**LIFEBUY:** TI has announced that the device will be discontinued, and a lifetime-buy period is in effect.

**NRND:** Not recommended for new designs. Device is in production to support existing customers, but TI does not recommend using this part in a new design.

**PREVIEW:** Device has been announced but is not in production. Samples may or may not be available.

**OBSELETE:** TI has discontinued the production of the device.

(2) **RoHS:** TI defines "RoHS" to mean semiconductor products that are compliant with the current EU RoHS requirements for all 10 RoHS substances, including the requirement that RoHS substance do not exceed 0.1% by weight in homogeneous materials. Where designed to be soldered at high temperatures, "RoHS" products are suitable for use in specified lead-free processes. TI may reference these types of products as "Pb-Free".

**RoHS Exempt:** TI defines "RoHS Exempt" to mean products that contain lead but are compliant with EU RoHS pursuant to a specific EU RoHS exemption.

**Green:** TI defines "Green" to mean the content of Chlorine (Cl) and Bromine (Br) based flame retardants meet JS709B low halogen requirements of <=1000ppm threshold. Antimony trioxide based flame retardants must also meet the <=1000ppm threshold requirement.

(3) MSL, Peak Temp. - The Moisture Sensitivity Level rating according to the JEDEC industry standard classifications, and peak solder temperature.

(4) There may be additional marking, which relates to the logo, the lot trace code information, or the environmental category on the device.

(5) Multiple Device Markings will be inside parentheses. Only one Device Marking contained in parentheses and separated by a "~" will appear on a device. If a line is indented then it is a continuation of the previous line and the two combined represent the entire Device Marking for that device.

(6) Lead finish/Ball material - Orderable Devices may have multiple material finish options. Finish options are separated by a vertical ruled line. Lead finish/Ball material values may wrap to two lines if the finish value exceeds the maximum column width.

**Important Information and Disclaimer:**The information provided on this page represents TI's knowledge and belief as of the date that it is provided. TI bases its knowledge and belief on information provided by third parties, and makes no representation or warranty as to the accuracy of such information. Efforts are underway to better integrate information from third parties. TI has taken and

continues to take reasonable steps to provide representative and accurate information but may not have conducted destructive testing or chemical analysis on incoming materials and chemicals. TI and TI suppliers consider certain information to be proprietary, and thus CAS numbers and other limited information may not be available for release.

In no event shall TI's liability arising out of such information exceed the total purchase price of the TI part(s) at issue in this document sold by TI to Customer on an annual basis.

**OTHER QUALIFIED VERSIONS OF TLV9001, TLV9002, TLV9004 :**

- Automotive : [TLV9001-Q1](#), [TLV9002-Q1](#), [TLV9004-Q1](#)

NOTE: Qualified Version Definitions:

- Automotive - Q100 devices qualified for high-reliability automotive applications targeting zero defects



**TAPE AND REEL INFORMATION**

**QUADRANT ASSIGNMENTS FOR PIN 1 ORIENTATION IN TAPE**


\*All dimensions are nominal

Device	Package Type	Package Drawing	Pins	SPQ	Reel Diameter (mm)	Reel Width W1 (mm)	A0 (mm)	B0 (mm)	K0 (mm)	P1 (mm)	W (mm)	Pin1 Quadrant
TLV9001IDBVR	SOT-23	DBV	5	3000	180.0	8.4	3.2	3.2	1.4	4.0	8.0	Q3
TLV9001IDCKR	SC70	DCK	5	3000	180.0	8.4	2.3	2.5	1.2	4.0	8.0	Q3
TLV9001IDPWR	X2SON	DPW	5	3000	178.0	8.4	0.91	0.91	0.5	2.0	8.0	Q2
TLV9001SIDBVR	SOT-23	DBV	6	3000	180.0	8.4	3.2	3.2	1.4	4.0	8.0	Q3
TLV9001SIDCKR	SC70	DCK	6	3000	180.0	8.4	2.3	2.5	1.2	4.0	8.0	Q3
TLV9001TIDCKR	SC70	DCK	5	3000	178.0	9.0	2.4	2.5	1.2	4.0	8.0	Q3
TLV9001UIDBVR	SOT-23	DBV	5	3000	180.0	8.4	3.2	3.2	1.4	4.0	8.0	Q3
TLV9001ZIDPWR	X2SON	DPW	5	3000	178.0	8.4	0.91	0.91	0.5	2.0	8.0	Q2
TLV9002IDDFR	SOT-23-THIN	DDF	8	3000	180.0	8.4	3.2	3.2	1.4	4.0	8.0	Q3
TLV9002IDGKR	VSSOP	DGK	8	2500	330.0	12.4	5.3	3.4	1.4	8.0	12.0	Q1
TLV9002IDGKT	VSSOP	DGK	8	250	330.0	12.4	5.3	3.4	1.4	8.0	12.0	Q1
TLV9002IDR	SOIC	D	8	2500	330.0	12.4	6.4	5.2	2.1	8.0	12.0	Q1
TLV9002IDSGR	WSOSON	DSG	8	3000	180.0	8.4	2.3	2.3	1.15	4.0	8.0	Q2
TLV9002IDSGT	WSOSON	DSG	8	250	180.0	8.4	2.3	2.3	1.15	4.0	8.0	Q2
TLV9002IPWR	TSSOP	PW	8	2000	330.0	12.4	7.0	3.6	1.6	8.0	12.0	Q1

Device	Package Type	Package Drawing	Pins	SPQ	Reel Diameter (mm)	Reel Width W1 (mm)	A0 (mm)	B0 (mm)	K0 (mm)	P1 (mm)	W (mm)	Pin1 Quadrant
TLV9002SIDGSR	VSSOP	DGS	10	2500	330.0	12.4	5.3	3.4	1.4	8.0	12.0	Q1
TLV9002SIRUGR	X2QFN	RUG	10	3000	178.0	8.4	1.75	2.25	0.56	4.0	8.0	Q1
TLV9002SIYCKR	DSBGA	YCK	9	3000	180.0	8.4	1.1	1.1	0.4	2.0	8.0	Q1
TLV9004IDR	SOIC	D	14	2500	330.0	16.4	6.5	9.0	2.1	8.0	16.0	Q1
TLV9004IDYYR	SOT-23-THIN	DYY	14	3000	330.0	12.4	4.8	3.6	1.6	8.0	12.0	Q3
TLV9004IPWR	TSSOP	PW	14	2000	330.0	12.4	6.9	5.6	1.6	8.0	12.0	Q1
TLV9004IRTER	WQFN	RTE	16	3000	330.0	12.4	3.3	3.3	1.1	8.0	12.0	Q2
TLV9004IRUCR	QFN	RUC	14	3000	180.0	9.5	2.16	2.16	0.5	4.0	8.0	Q2
TLV9004SIRTER	WQFN	RTE	16	3000	330.0	12.4	3.3	3.3	1.1	8.0	12.0	Q2

**TAPE AND REEL BOX DIMENSIONS**


\*All dimensions are nominal

Device	Package Type	Package Drawing	Pins	SPQ	Length (mm)	Width (mm)	Height (mm)
TLV9001IDBVR	SOT-23	DBV	5	3000	210.0	185.0	35.0
TLV9001IDCKR	SC70	DCK	5	3000	210.0	185.0	35.0
TLV9001IDPWR	X2SON	DPW	5	3000	205.0	200.0	33.0
TLV9001SIDBVR	SOT-23	DBV	6	3000	210.0	185.0	35.0
TLV9001SIDCKR	SC70	DCK	6	3000	210.0	185.0	35.0
TLV9001TIDCKR	SC70	DCK	5	3000	190.0	190.0	30.0
TLV9001UIDBVR	SOT-23	DBV	5	3000	210.0	185.0	35.0
TLV9001ZIDPWR	X2SON	DPW	5	3000	205.0	200.0	33.0
TLV9002IDDFR	SOT-23-THIN	DDF	8	3000	210.0	185.0	35.0
TLV9002IDGKR	VSSOP	DGK	8	2500	356.0	356.0	35.0
TLV9002IDGKT	VSSOP	DGK	8	250	356.0	356.0	35.0
TLV9002IDR	SOIC	D	8	2500	356.0	356.0	35.0
TLV9002IDSGR	WSON	DSG	8	3000	210.0	185.0	35.0
TLV9002IDSGT	WSON	DSG	8	250	210.0	185.0	35.0
TLV9002IPWR	TSSOP	PW	8	2000	356.0	356.0	35.0
TLV9002SIDGSR	VSSOP	DGS	10	2500	366.0	364.0	50.0
TLV9002SIRUGR	X2QFN	RUG	10	3000	205.0	200.0	33.0
TLV9002SIYCKR	DSBGA	YCK	9	3000	182.0	182.0	20.0

---

<b>Device</b>	<b>Package Type</b>	<b>Package Drawing</b>	<b>Pins</b>	<b>SPQ</b>	<b>Length (mm)</b>	<b>Width (mm)</b>	<b>Height (mm)</b>
TLV9004IDR	SOIC	D	14	2500	356.0	356.0	35.0
TLV9004IDYYR	SOT-23-THIN	DYY	14	3000	336.6	336.6	31.8
TLV9004IPWR	TSSOP	PW	14	2000	356.0	356.0	35.0
TLV9004IRTER	WQFN	RTE	16	3000	367.0	367.0	35.0
TLV9004IRUCR	QFN	RUC	14	3000	205.0	200.0	30.0
TLV9004SIRTER	WQFN	RTE	16	3000	367.0	367.0	35.0

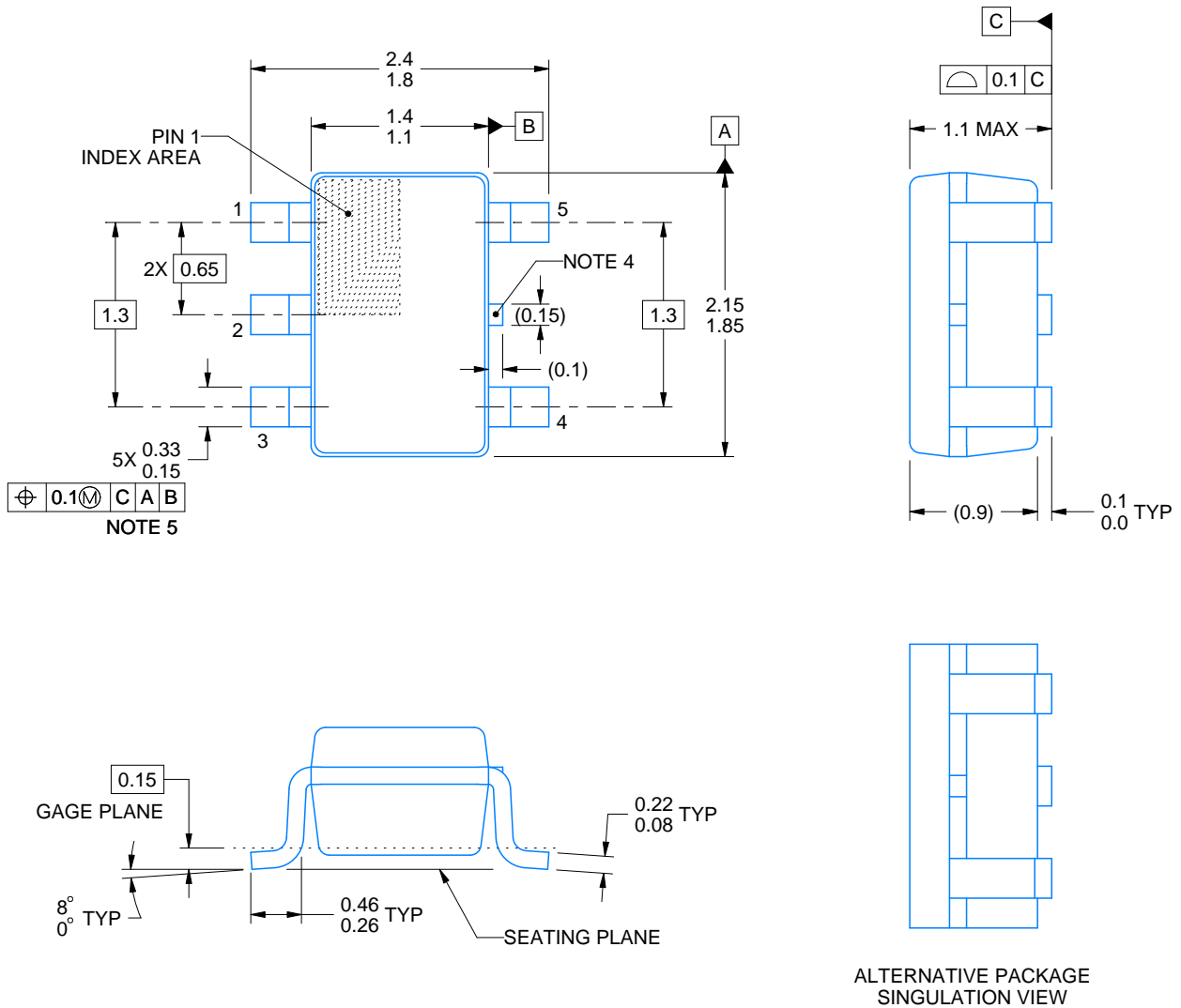
# DCK0005A



## PACKAGE OUTLINE

SOT - 1.1 max height

SMALL OUTLINE TRANSISTOR



4214834/E 06/2024

### NOTES:

1. All linear dimensions are in millimeters. Any dimensions in parenthesis are for reference only. Dimensioning and tolerancing per ASME Y14.5M.
2. This drawing is subject to change without notice.
3. Reference JEDEC MO-203.
4. Support pin may differ or may not be present.
5. Lead width does not comply with JEDEC.
6. Body dimensions do not include mold flash, protrusions, or gate burrs. Mold flash, protrusions, or gate burrs shall not exceed 0.25mm per side

# EXAMPLE BOARD LAYOUT

DCK0005A

SOT - 1.1 max height

SMALL OUTLINE TRANSISTOR



LAND PATTERN EXAMPLE  
EXPOSED METAL SHOWN  
SCALE:18X



SOLDER MASK DETAILS

4214834/E 06/2024

NOTES: (continued)

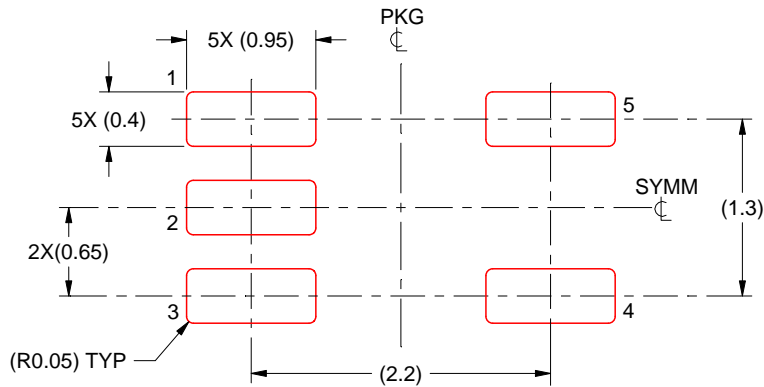
- 7. Publication IPC-7351 may have alternate designs.
- 8. Solder mask tolerances between and around signal pads can vary based on board fabrication site.

# EXAMPLE STENCIL DESIGN

DCK0005A

SOT - 1.1 max height

SMALL OUTLINE TRANSISTOR



SOLDER PASTE EXAMPLE  
BASED ON 0.125 THICK STENCIL  
SCALE: 18X

4214834/E 06/2024

NOTES: (continued)

9. Laser cutting apertures with trapezoidal walls and rounded corners may offer better paste release. IPC-7525 may have alternate design recommendations.
10. Board assembly site may have different recommendations for stencil design.

# DGK0008A



# PACKAGE OUTLINE

VSSOP - 1.1 mm max height

SMALL OUTLINE PACKAGE



**NOTES:**

PowerPAD is a trademark of Texas Instruments.

1. All linear dimensions are in millimeters. Any dimensions in parenthesis are for reference only. Dimensioning and tolerancing per ASME Y14.5M.
2. This drawing is subject to change without notice.
3. This dimension does not include mold flash, protrusions, or gate burrs. Mold flash, protrusions, or gate burrs shall not exceed 0.15 mm per side.
4. This dimension does not include interlead flash. Interlead flash shall not exceed 0.25 mm per side.
5. Reference JEDEC registration MO-187.



# EXAMPLE BOARD LAYOUT

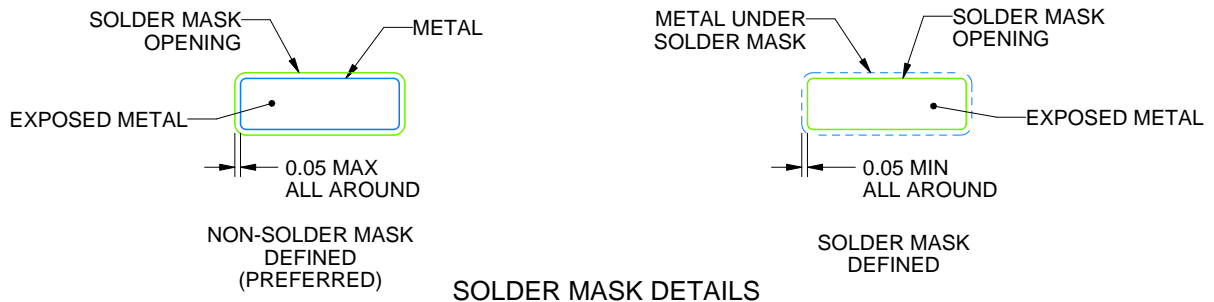
DGK0008A

™ VSSOP - 1.1 mm max height

SMALL OUTLINE PACKAGE



LAND PATTERN EXAMPLE  
EXPOSED METAL SHOWN  
SCALE: 15X



SOLDER MASK DETAILS

4214862/A 04/2023

NOTES: (continued)

6. Publication IPC-7351 may have alternate designs.
7. Solder mask tolerances between and around signal pads can vary based on board fabrication site.
8. Vias are optional depending on application, refer to device data sheet. If any vias are implemented, refer to their locations shown on this view. It is recommended that vias under paste be filled, plugged or tented.
9. Size of metal pad may vary due to creepage requirement.

# EXAMPLE STENCIL DESIGN

DGK0008A

<sup>TM</sup> VSSOP - 1.1 mm max height

SMALL OUTLINE PACKAGE



SOLDER PASTE EXAMPLE  
SCALE: 15X

4214862/A 04/2023

NOTES: (continued)

11. Laser cutting apertures with trapezoidal walls and rounded corners may offer better paste release. IPC-7525 may have alternate design recommendations.
12. Board assembly site may have different recommendations for stencil design.

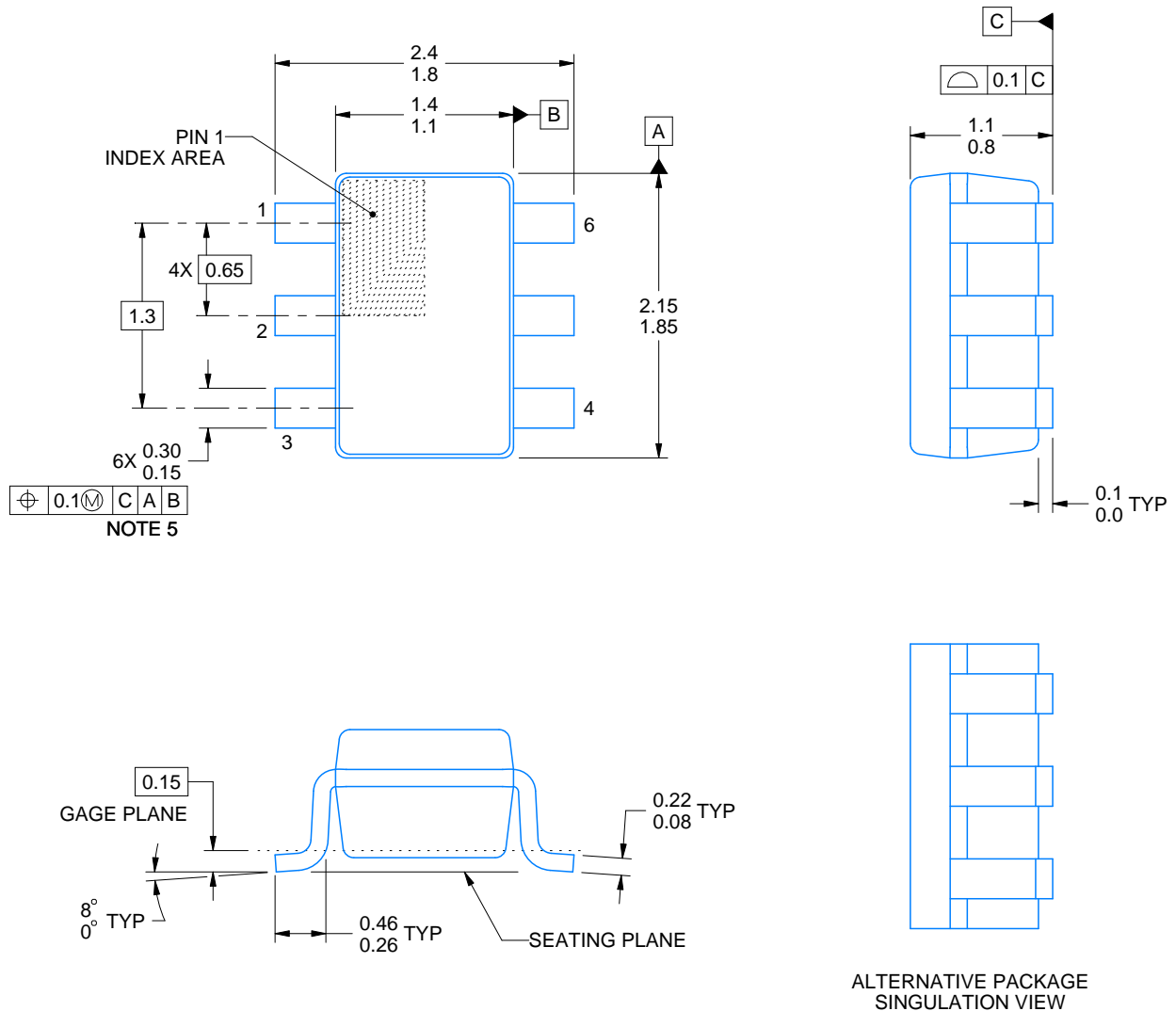
# DCK0006A



# PACKAGE OUTLINE

SOT - 1.1 max height

SMALL OUTLINE TRANSISTOR

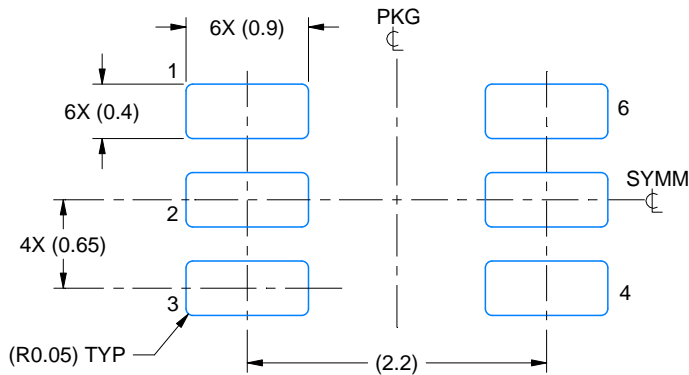


ALTERNATIVE PACKAGE SINGULATION VIEW

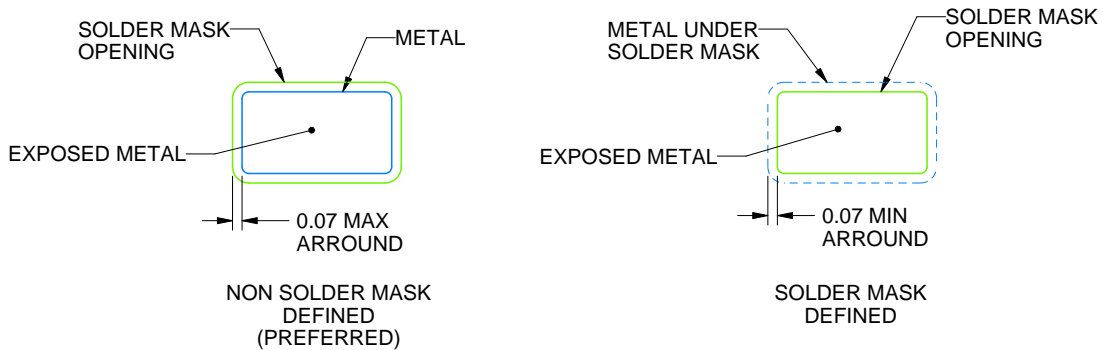
4214835/B 04/2024

NOTES:

1. All linear dimensions are in millimeters. Any dimensions in parenthesis are for reference only. Dimensioning and tolerancing per ASME Y14.5M.
2. This drawing is subject to change without notice.
3. Body dimensions do not include mold flash or protrusion. Mold flash and protrusion shall not exceed 0.15 per side.
4. Falls within JEDEC MO-203 variation AB.



LAND PATTERN EXAMPLE  
EXPOSED METAL SHOWN  
SCALE:18X

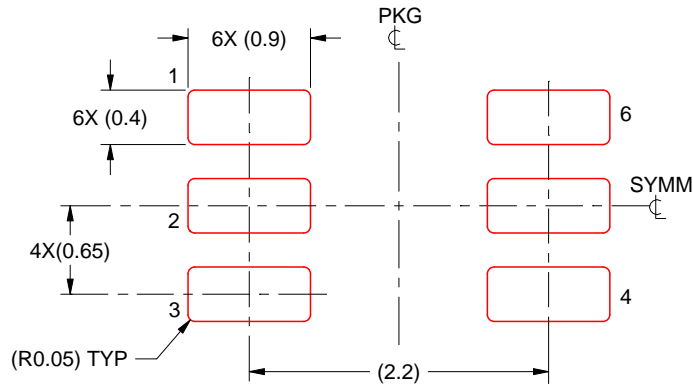


SOLDER MASK DETAILS

4214835/B 04/2024

NOTES: (continued)

- 5. Publication IPC-7351 may have alternate designs.
- 6. Solder mask tolerances between and around signal pads can vary based on board fabrication site.



SOLDER PASTE EXAMPLE  
BASED ON 0.125 THICK STENCIL  
SCALE:18X

4214835/B 04/2024

NOTES: (continued)

7. Laser cutting apertures with trapezoidal walls and rounded corners may offer better paste release. IPC-7525 may have alternate design recommendations.
8. Board assembly site may have different recommendations for stencil design.

## GENERIC PACKAGE VIEW

**RTE 16**

**WQFN - 0.8 mm max height**

3 x 3, 0.5 mm pitch

PLASTIC QUAD FLATPACK - NO LEAD

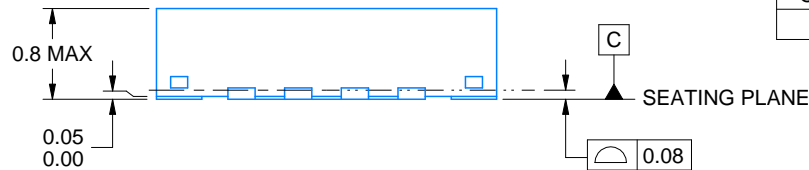
This image is a representation of the package family, actual package may vary.  
Refer to the product data sheet for package details.



4225944/A



SIDE WALL METAL THICKNESS DIM A	
OPTION 1	OPTION 2
0.1	0.2



4219117/B 04/2022

NOTES:

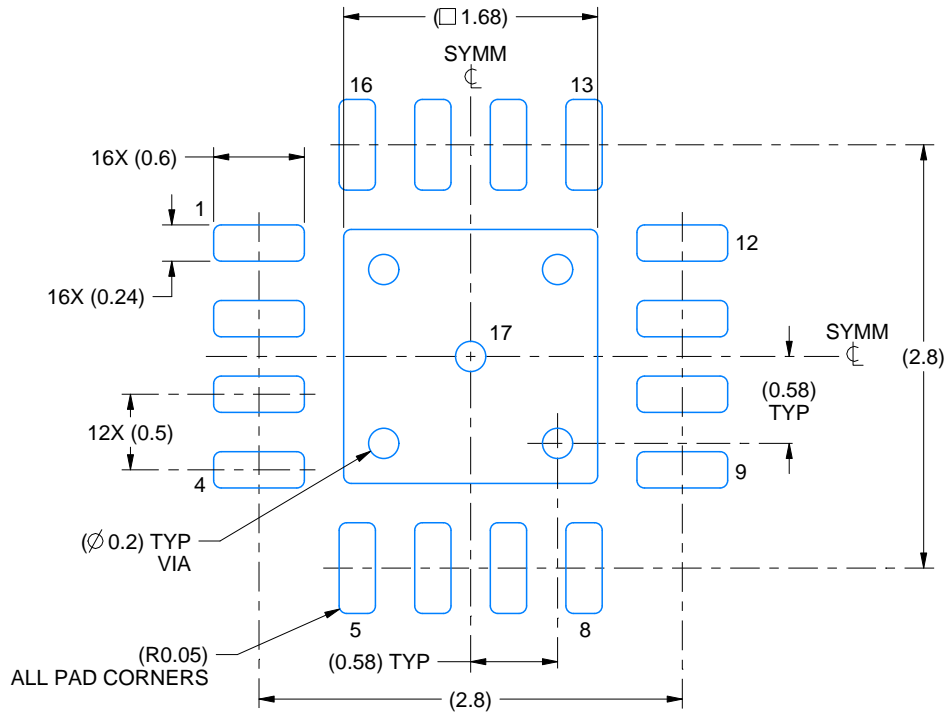
1. All linear dimensions are in millimeters. Any dimensions in parenthesis are for reference only. Dimensioning and tolerancing per ASME Y14.5M.
2. This drawing is subject to change without notice.
3. The package thermal pad must be soldered to the printed circuit board for thermal and mechanical performance.

# EXAMPLE BOARD LAYOUT

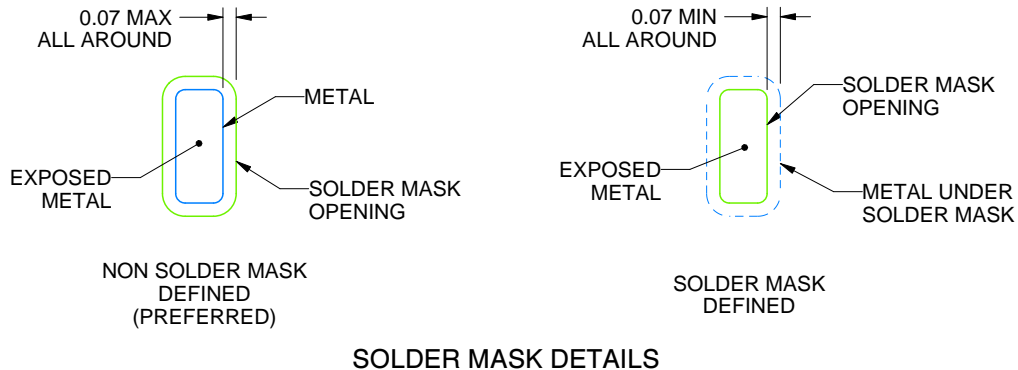
RTE0016C

WQFN - 0.8 mm max height

PLASTIC QUAD FLATPACK - NO LEAD



LAND PATTERN EXAMPLE  
EXPOSED METAL SHOWN  
SCALE:20X



4219117/B 04/2022

NOTES: (continued)

- This package is designed to be soldered to a thermal pad on the board. For more information, see Texas Instruments literature number SLUA271 ([www.ti.com/lit/slua271](http://www.ti.com/lit/slua271)).
- Vias are optional depending on application, refer to device data sheet. If any vias are implemented, refer to their locations shown on this view. It is recommended that vias under paste be filled, plugged or tented.



# EXAMPLE STENCIL DESIGN

RTE0016C

WQFN - 0.8 mm max height

PLASTIC QUAD FLATPACK - NO LEAD



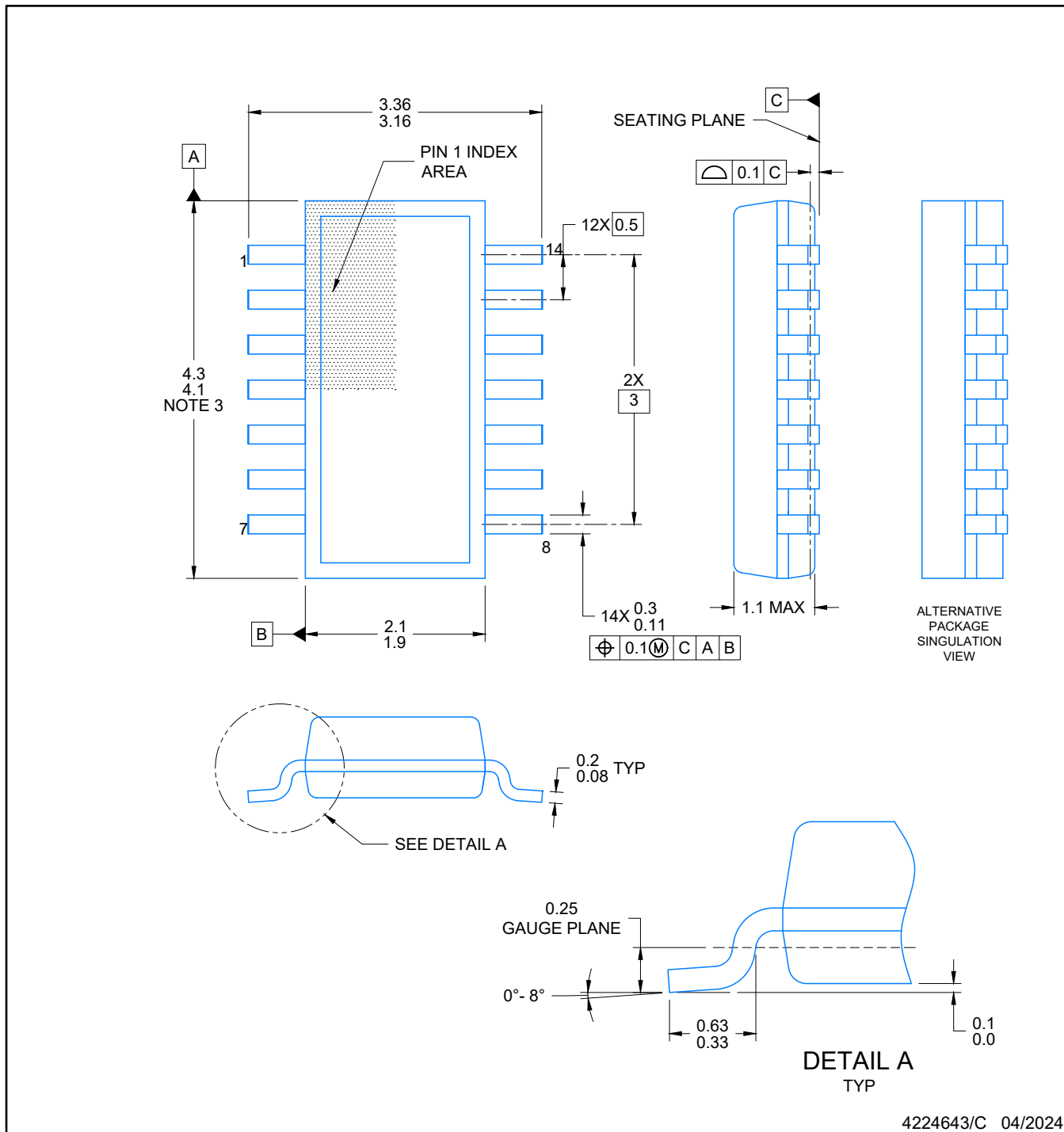
**SOLDER PASTE EXAMPLE**  
BASED ON 0.125 mm THICK STENCIL

EXPOSED PAD 17:  
85% PRINTED SOLDER COVERAGE BY AREA UNDER PACKAGE  
SCALE:25X

4219117/B 04/2022

NOTES: (continued)

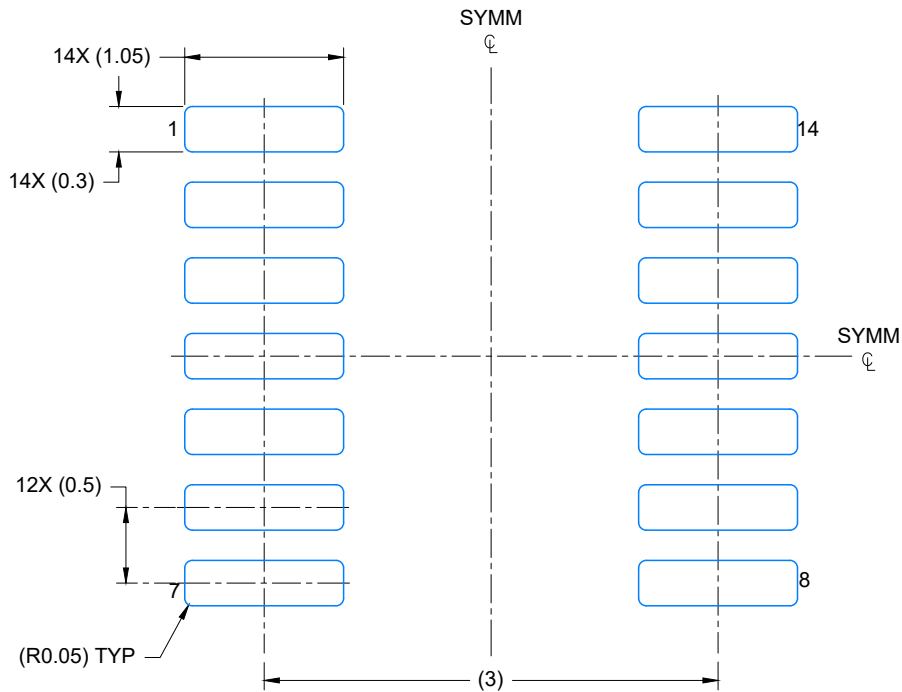
6. Laser cutting apertures with trapezoidal walls and rounded corners may offer better paste release. IPC-7525 may have alternate design recommendations.



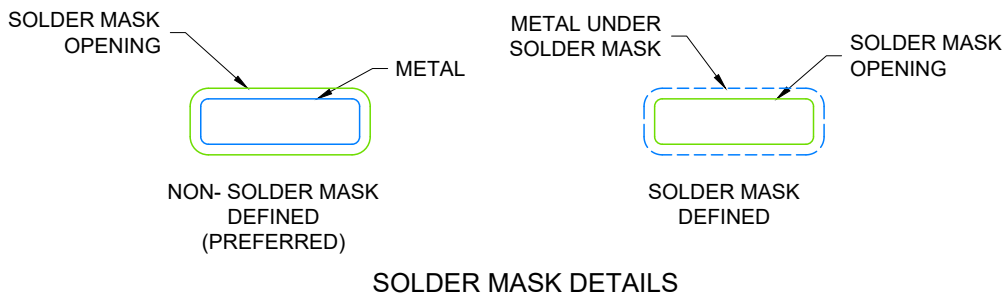
4224643/C 04/2024

NOTES:

1. All linear dimensions are in millimeters. Any dimensions in parenthesis are for reference only. Dimensioning and tolerancing per ASME Y14.5M.
2. This drawing is subject to change without notice.
3. This dimension does not include mold flash, protrusions, or gate burrs. Mold flash, protrusions, or gate burrs shall not exceed 0.15 per side.
4. This dimension does not include interlead flash. Interlead flash shall not exceed 0.50 per side.
5. Reference JEDEC Registration MO-345, Variation AB



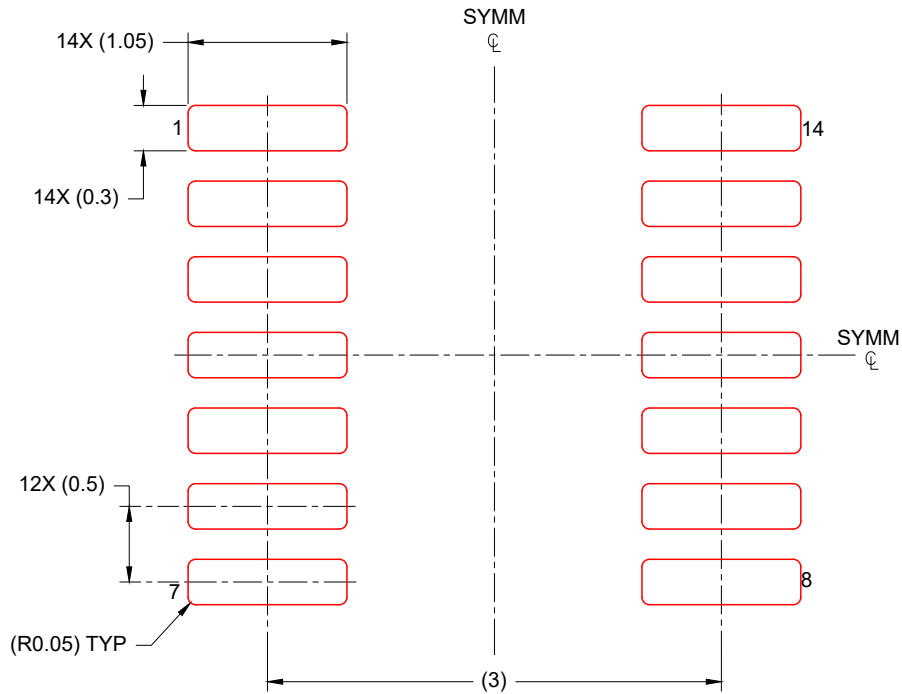
LAND PATTERN EXAMPLE  
EXPOSED METAL SHOWN  
SCALE: 20X



4224643/C 04/2024

NOTES: (continued)

- 6. Publication IPC-7351 may have alternate designs.
- 7. Solder mask tolerances between and around signal pads can vary based on board fabrication site.



SOLDER PASTE EXAMPLE  
BASED ON 0.125 mm THICK STENCIL  
SCALE: 20X

4224643/C 04/2024

NOTES: (continued)

8. Laser cutting apertures with trapezoidal walls and rounded corners may offer better paste release. IPC-7525 may have alternate design recommendations.
9. Board assembly site may have different recommendations for stencil design.

# DGS0010A



# PACKAGE OUTLINE

## VSSOP - 1.1 mm max height

SMALL OUTLINE PACKAGE



4221984/A 05/2015

### NOTES:

1. All linear dimensions are in millimeters. Any dimensions in parenthesis are for reference only. Dimensioning and tolerancing per ASME Y14.5M.
2. This drawing is subject to change without notice.
3. This dimension does not include mold flash, protrusions, or gate burrs. Mold flash, protrusions, or gate burrs shall not exceed 0.15 mm per side.
4. This dimension does not include interlead flash. Interlead flash shall not exceed 0.25 mm per side.
5. Reference JEDEC registration MO-187, variation BA.

# EXAMPLE BOARD LAYOUT

DGS0010A

VSSOP - 1.1 mm max height

SMALL OUTLINE PACKAGE



LAND PATTERN EXAMPLE  
SCALE:10X



SOLDER MASK DETAILS  
NOT TO SCALE

4221984/A 05/2015

NOTES: (continued)

- 6. Publication IPC-7351 may have alternate designs.
- 7. Solder mask tolerances between and around signal pads can vary based on board fabrication site.

# EXAMPLE STENCIL DESIGN

DGS0010A

VSSOP - 1.1 mm max height

SMALL OUTLINE PACKAGE



SOLDER PASTE EXAMPLE  
BASED ON 0.125 mm THICK STENCIL  
SCALE:10X

4221984/A 05/2015

NOTES: (continued)

8. Laser cutting apertures with trapezoidal walls and rounded corners may offer better paste release. IPC-7525 may have alternate design recommendations.
9. Board assembly site may have different recommendations for stencil design.

## GENERIC PACKAGE VIEW

DPW 5

X2SON - 0.4 mm max height

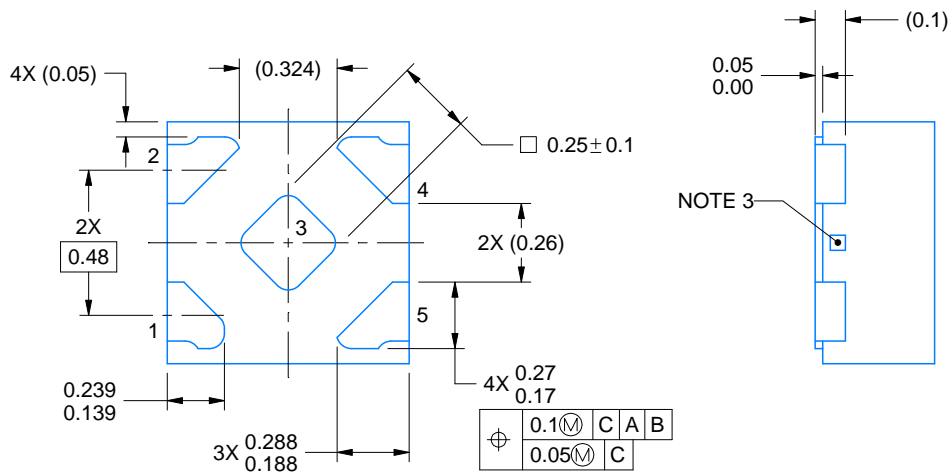
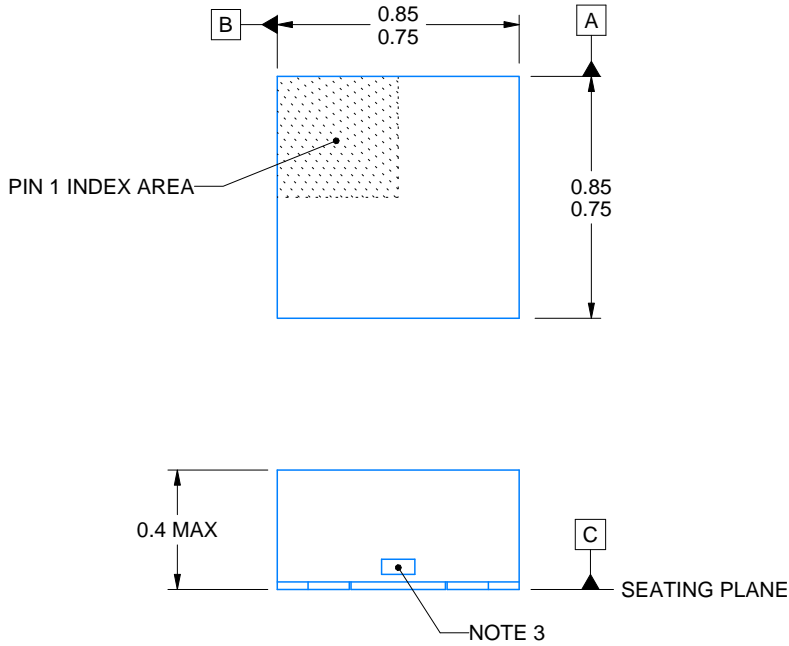
PLASTIC SMALL OUTLINE - NO LEAD



Images above are just a representation of the package family, actual package may vary.  
Refer to the product data sheet for package details.

4211218-3/D





4223102/D 03/2022

NOTES:

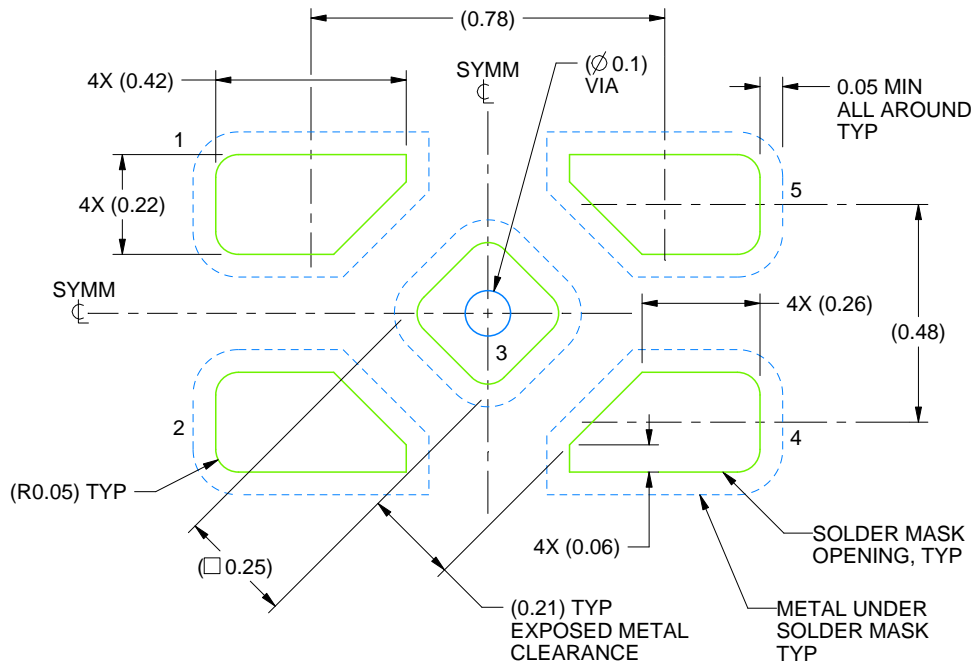
1. All linear dimensions are in millimeters. Any dimensions in parenthesis are for reference only. Dimensioning and tolerancing per ASME Y14.5M.
2. This drawing is subject to change without notice.
3. The size and shape of this feature may vary.

# EXAMPLE BOARD LAYOUT

DPW0005A

X2SON - 0.4 mm max height

PLASTIC SMALL OUTLINE - NO LEAD



LAND PATTERN EXAMPLE  
SOLDER MASK DEFINED  
SCALE:60X

4223102/D 03/2022

NOTES: (continued)

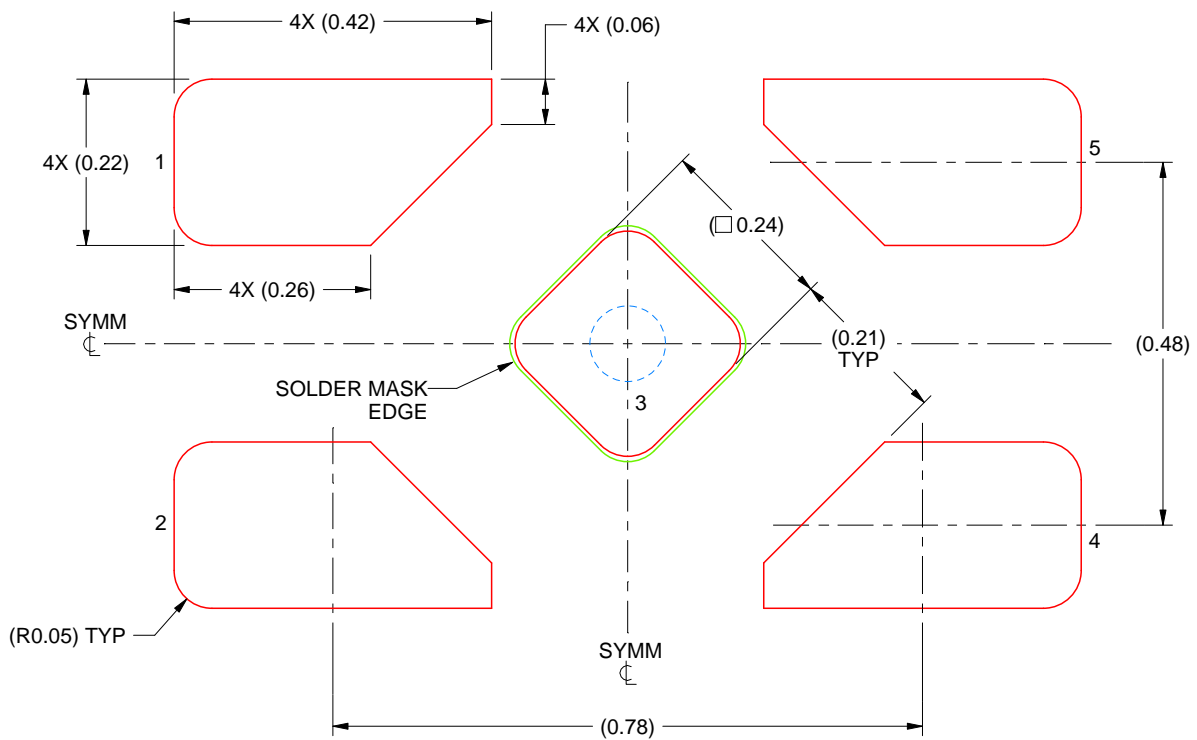
4. This package is designed to be soldered to a thermal pad on the board. For more information, refer to QFN/SON PCB application note in literature No. SLUA271 ([www.ti.com/lit/sluea271](http://www.ti.com/lit/sluea271)).

# EXAMPLE STENCIL DESIGN

DPW0005A

X2SON - 0.4 mm max height

PLASTIC SMALL OUTLINE - NO LEAD



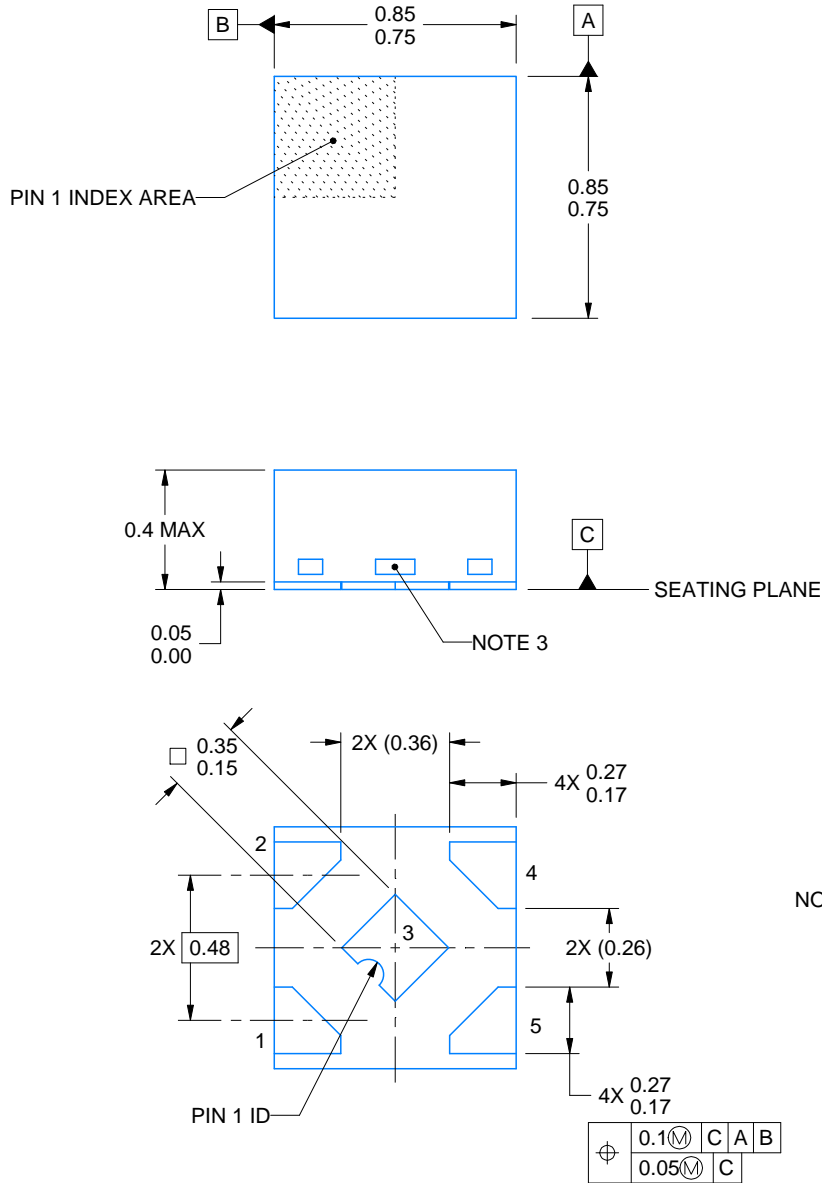
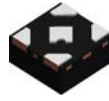
SOLDER PASTE EXAMPLE  
BASED ON 0.1 mm THICK STENCIL

EXPOSED PAD 3  
92% PRINTED SOLDER COVERAGE BY AREA UNDER PACKAGE  
SCALE:100X

4223102/D 03/2022

NOTES: (continued)

5. Laser cutting apertures with trapezoidal walls and rounded corners may offer better paste release. IPC-7525 may have alternate design recommendations.



4228233/D 09/2023

NOTES:

1. All linear dimensions are in millimeters. Any dimensions in parenthesis are for reference only. Dimensioning and tolerancing per ASME Y14.5M.
2. This drawing is subject to change without notice.
3. The size and shape of this feature may vary.

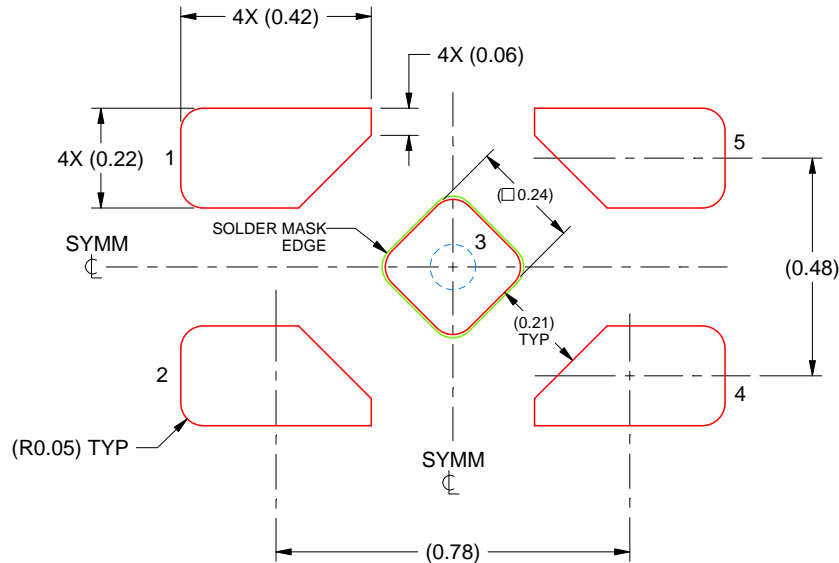


# EXAMPLE STENCIL DESIGN

DPW0005B

X2SON - 0.4 mm max height

PLASTIC SMALL OUTLINE - NO LEAD



SOLDER PASTE EXAMPLE  
BASED ON 0.1 mm THICK STENCIL

EXPOSED PAD 5  
92% PRINTED SOLDER COVERAGE BY AREA UNDER PACKAGE  
SCALE:60X

4228233/D 09/2023

NOTES: (continued)

5. Laser cutting apertures with trapezoidal walls and rounded corners may offer better paste release. IPC-7525 may have alternate design recommendations.

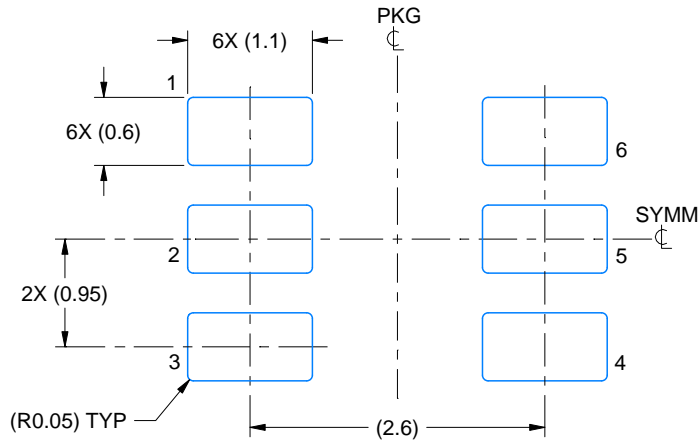


# EXAMPLE BOARD LAYOUT

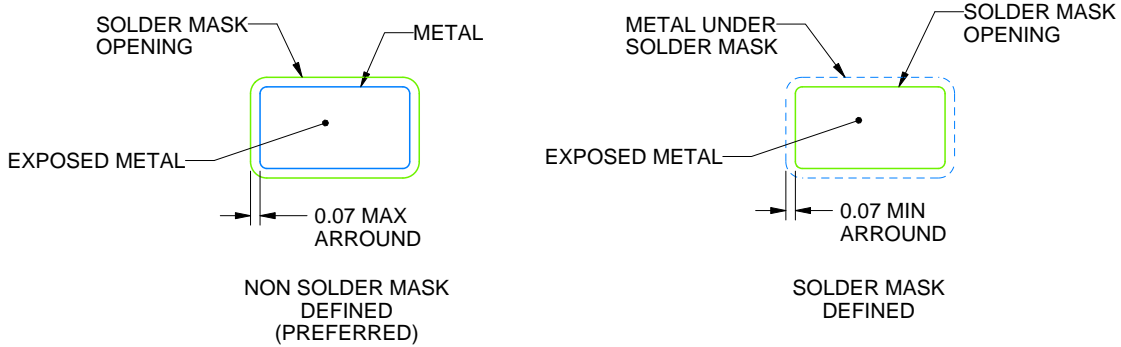
DBV0006A

SOT-23 - 1.45 mm max height

SMALL OUTLINE TRANSISTOR



LAND PATTERN EXAMPLE  
EXPOSED METAL SHOWN  
SCALE:15X



SOLDER MASK DETAILS

4214840/F 05/2024

NOTES: (continued)

- 6. Publication IPC-7351 may have alternate designs.
- 7. Solder mask tolerances between and around signal pads can vary based on board fabrication site.

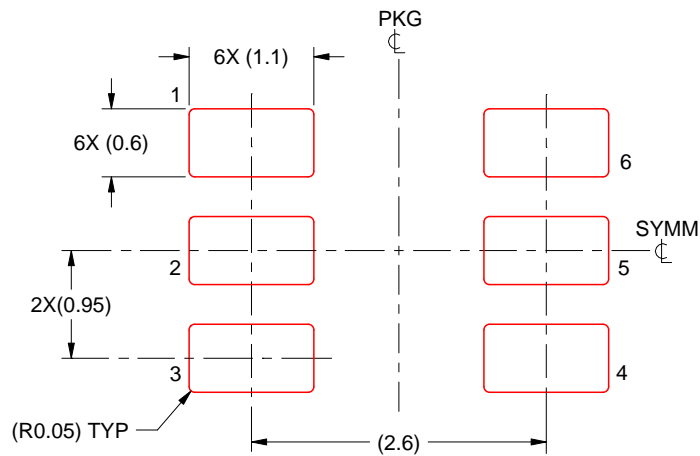


# EXAMPLE STENCIL DESIGN

DBV0006A

SOT-23 - 1.45 mm max height

SMALL OUTLINE TRANSISTOR



SOLDER PASTE EXAMPLE  
BASED ON 0.125 mm THICK STENCIL  
SCALE:15X

4214840/F 05/2024

NOTES: (continued)

8. Laser cutting apertures with trapezoidal walls and rounded corners may offer better paste release. IPC-7525 may have alternate design recommendations.
9. Board assembly site may have different recommendations for stencil design.

## GENERIC PACKAGE VIEW

**DSG 8**

**WSON - 0.8 mm max height**

2 x 2, 0.5 mm pitch

PLASTIC SMALL OUTLINE - NO LEAD

This image is a representation of the package family, actual package may vary.  
Refer to the product data sheet for package details.



4224783/A

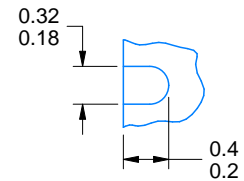
# DSG0008A



# PACKAGE OUTLINE

## WSON - 0.8 mm max height

PLASTIC SMALL OUTLINE - NO LEAD



ALTERNATIVE TERMINAL SHAPE TYPICAL



SIDE WALL METAL THICKNESS DIM A	
OPTION 1	OPTION 2
0.1	0.2



4218900/E 08/2022

### NOTES:

1. All linear dimensions are in millimeters. Any dimensions in parenthesis are for reference only. Dimensioning and tolerancing per ASME Y14.5M.
2. This drawing is subject to change without notice.
3. The package thermal pad must be soldered to the printed circuit board for thermal and mechanical performance.



# EXAMPLE STENCIL DESIGN

DSG0008A

WSON - 0.8 mm max height

PLASTIC SMALL OUTLINE - NO LEAD



SOLDER PASTE EXAMPLE  
BASED ON 0.125 mm THICK STENCIL

EXPOSED PAD 9:  
87% PRINTED SOLDER COVERAGE BY AREA UNDER PACKAGE  
SCALE:25X

4218900/E 08/2022

NOTES: (continued)

6. Laser cutting apertures with trapezoidal walls and rounded corners may offer better paste release. IPC-7525 may have alternate design recommendations.

PW0008A



**PACKAGE OUTLINE**  
**TSSOP - 1.2 mm max height**

SMALL OUTLINE PACKAGE



4221848/A 02/2015

NOTES:

- All linear dimensions are in millimeters. Any dimensions in parenthesis are for reference only. Dimensioning and tolerancing per ASME Y14.5M.
- This drawing is subject to change without notice.
- This dimension does not include mold flash, protrusions, or gate burrs. Mold flash, protrusions, or gate burrs shall not exceed 0.15 mm per side.
- This dimension does not include interlead flash. Interlead flash shall not exceed 0.25 mm per side.
- Reference JEDEC registration MO-153, variation AA.

# EXAMPLE BOARD LAYOUT

PW0008A

TSSOP - 1.2 mm max height

SMALL OUTLINE PACKAGE



LAND PATTERN EXAMPLE  
SCALE:10X



SOLDER MASK DETAILS  
NOT TO SCALE

4221848/A 02/2015

NOTES: (continued)

- 6. Publication IPC-7351 may have alternate designs.
- 7. Solder mask tolerances between and around signal pads can vary based on board fabrication site.

# EXAMPLE STENCIL DESIGN

PW0008A

TSSOP - 1.2 mm max height

SMALL OUTLINE PACKAGE



SOLDER PASTE EXAMPLE  
BASED ON 0.125 mm THICK STENCIL  
SCALE:10X

4221848/A 02/2015

NOTES: (continued)

8. Laser cutting apertures with trapezoidal walls and rounded corners may offer better paste release. IPC-7525 may have alternate design recommendations.
9. Board assembly site may have different recommendations for stencil design.



## GENERIC PACKAGE VIEW

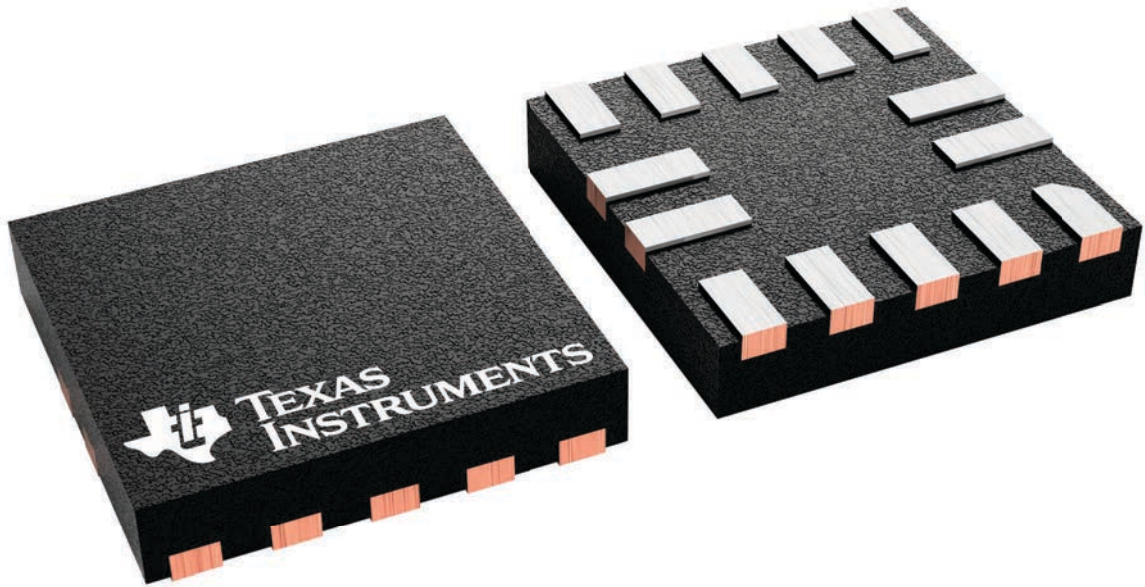
**RUC 14**

**X2QFN - 0.4 mm max height**

2 x 2, 0.4 mm pitch

PLASTIC QUAD FLATPACK - NO LEAD

This image is a representation of the package family, actual package may vary.  
Refer to the product data sheet for package details.



4229871/A



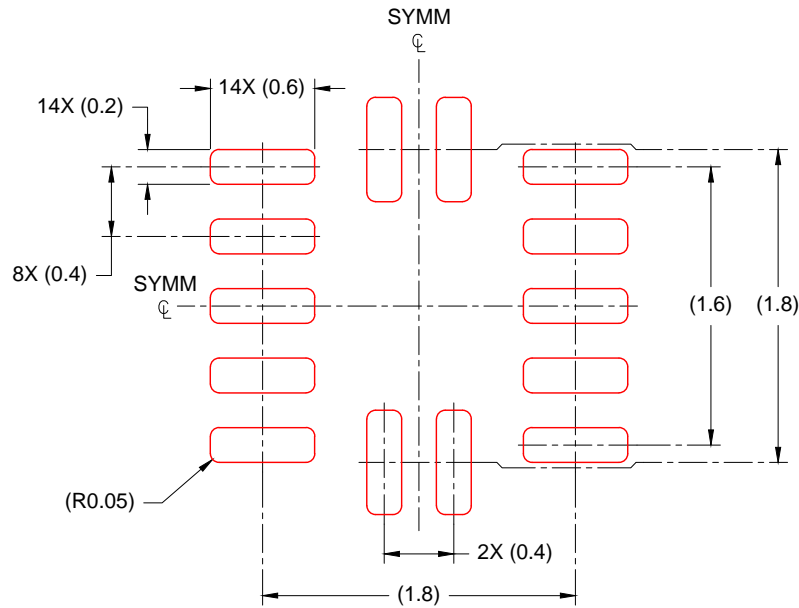


# EXAMPLE STENCIL DESIGN

RUC0014A

X2QFN - 0.4 mm max height

PLASTIC QUAD FLAT PACK- NO LEAD



SOLDER PASTE EXAMPLE  
BASED ON 0.100mm THICK STENCIL  
SCALE: 23X

4220584/A 05/2019

NOTES: (continued)

4. Laser cutting apertures with trapezoidal walls and rounded corners may offer better paste release. IPC-7525 may have alternate design recommendations.

# DBV0005A



# PACKAGE OUTLINE

SOT-23 - 1.45 mm max height

SMALL OUTLINE TRANSISTOR



4214839/J 02/2024

**NOTES:**

1. All linear dimensions are in millimeters. Any dimensions in parenthesis are for reference only. Dimensioning and tolerancing per ASME Y14.5M.
2. This drawing is subject to change without notice.
3. Reference JEDEC MO-178.
4. Body dimensions do not include mold flash, protrusions, or gate burrs. Mold flash, protrusions, or gate burrs shall not exceed 0.25 mm per side.
5. Support pin may differ or may not be present.

# EXAMPLE BOARD LAYOUT

DBV0005A

SOT-23 - 1.45 mm max height

SMALL OUTLINE TRANSISTOR



LAND PATTERN EXAMPLE  
EXPOSED METAL SHOWN  
SCALE:15X



SOLDER MASK DETAILS

4214839/J 02/2024

NOTES: (continued)

- 6. Publication IPC-7351 may have alternate designs.
- 7. Solder mask tolerances between and around signal pads can vary based on board fabrication site.

# EXAMPLE STENCIL DESIGN

DBV0005A

SOT-23 - 1.45 mm max height

SMALL OUTLINE TRANSISTOR



SOLDER PASTE EXAMPLE  
BASED ON 0.125 mm THICK STENCIL  
SCALE:15X

4214839/J 02/2024

NOTES: (continued)

8. Laser cutting apertures with trapezoidal walls and rounded corners may offer better paste release. IPC-7525 may have alternate design recommendations.
9. Board assembly site may have different recommendations for stencil design.

D (R-PDSO-G14)

PLASTIC SMALL OUTLINE



- NOTES:
- A. All linear dimensions are in inches (millimeters).
  - B. This drawing is subject to change without notice.
  -  Body length does not include mold flash, protrusions, or gate burrs. Mold flash, protrusions, or gate burrs shall not exceed 0.006 (0,15) each side.
  -  Body width does not include interlead flash. Interlead flash shall not exceed 0.017 (0,43) each side.
  - E. Reference JEDEC MS-012 variation AB.



PW (R-PDSO-G14)

PLASTIC SMALL OUTLINE



- NOTES:
- A. All linear dimensions are in millimeters. Dimensioning and tolerancing per ASME Y14.5M-1994.
  - B. This drawing is subject to change without notice.
  - C. Body length does not include mold flash, protrusions, or gate burrs. Mold flash, protrusions, or gate burrs shall not exceed 0,15 each side.
  - D. Body width does not include interlead flash. Interlead flash shall not exceed 0,25 each side.
  - E. Falls within JEDEC MO-153

PW (R-PDSO-G14)

PLASTIC SMALL OUTLINE



- NOTES:
- All linear dimensions are in millimeters.
  - This drawing is subject to change without notice.
  - Publication IPC-7351 is recommended for alternate designs.
  - Laser cutting apertures with trapezoidal walls and also rounding corners will offer better paste release. Customers should contact their board assembly site for stencil design recommendations. Refer to IPC-7525 for other stencil recommendations.
  - Customers should contact their board fabrication site for solder mask tolerances between and around signal pads.

# DDF0008A



# PACKAGE OUTLINE

## SOT-23-THIN - 1.1 mm max height

PLASTIC SMALL OUTLINE



4222047/E 07/2024

### NOTES:

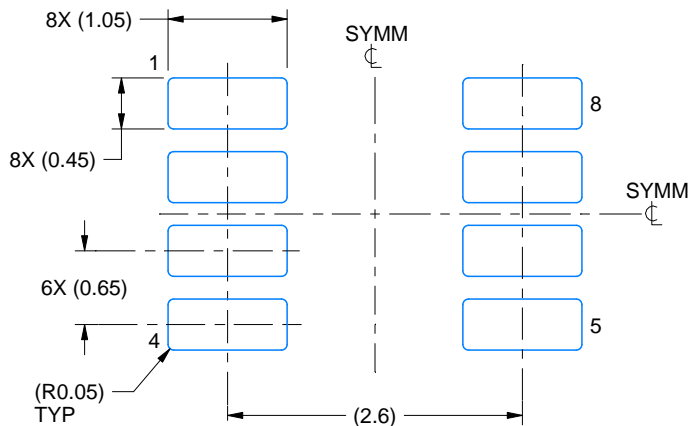
1. All linear dimensions are in millimeters. Any dimensions in parenthesis are for reference only. Dimensioning and tolerancing per ASME Y14.5M.
2. This drawing is subject to change without notice.
3. This dimension does not include mold flash, protrusions, or gate burrs. Mold flash, protrusions, or gate burrs shall not exceed 0.15 mm per side.

# EXAMPLE BOARD LAYOUT

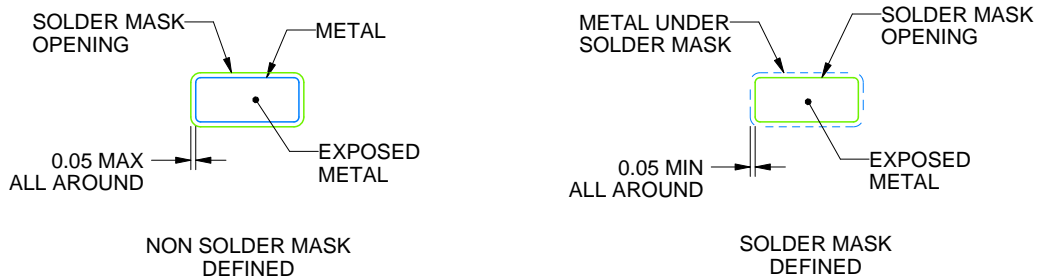
DDF0008A

SOT-23-THIN - 1.1 mm max height

PLASTIC SMALL OUTLINE



LAND PATTERN EXAMPLE  
EXPOSED METAL SHOWN  
SCALE:15X



SOLDER MASK DETAILS

4222047/E 07/2024

NOTES: (continued)

- 4. Publication IPC-7351 may have alternate designs.
- 5. Solder mask tolerances between and around signal pads can vary based on board fabrication site.

# EXAMPLE STENCIL DESIGN

DDF0008A

SOT-23-THIN - 1.1 mm max height

PLASTIC SMALL OUTLINE



SOLDER PASTE EXAMPLE  
BASED ON 0.125 mm THICK STENCIL  
SCALE:15X

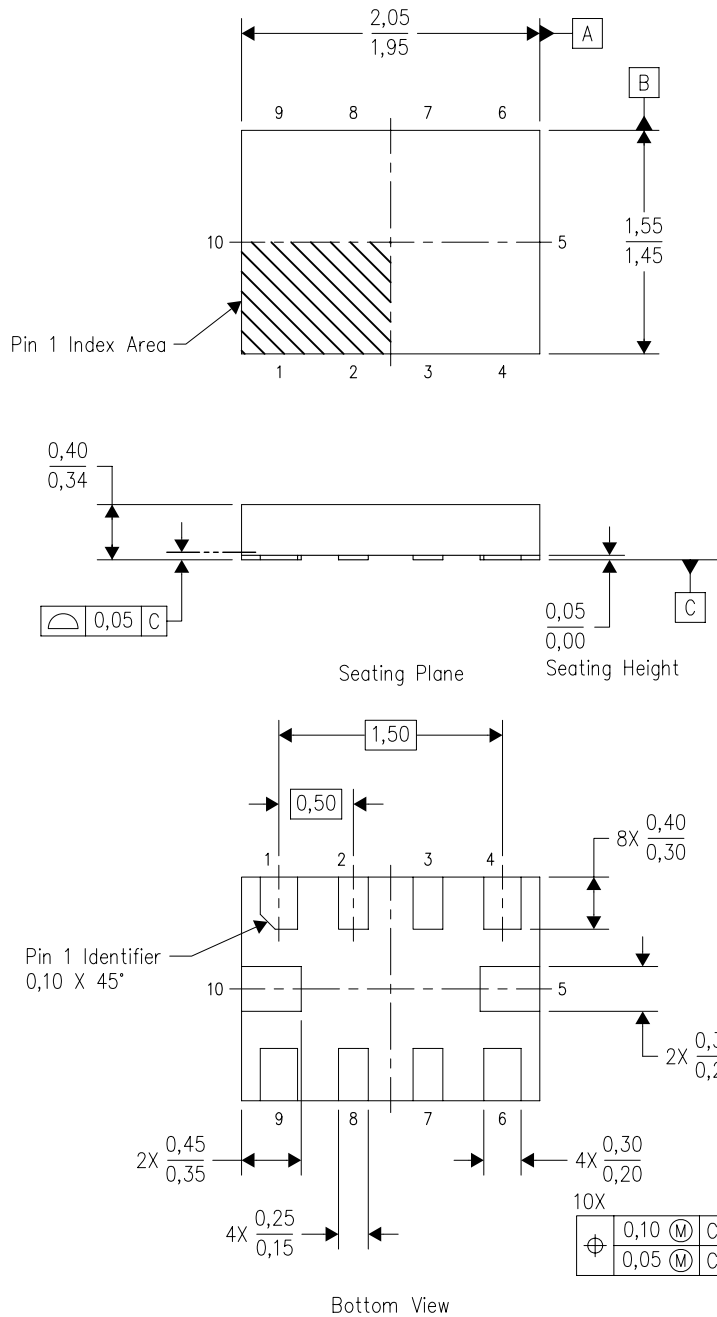
4222047/E 07/2024

NOTES: (continued)

6. Laser cutting apertures with trapezoidal walls and rounded corners may offer better paste release. IPC-7525 may have alternate design recommendations.
7. Board assembly site may have different recommendations for stencil design.

RUG (R-PQFP-N10)

PLASTIC QUAD FLATPACK



4208528-3/B 04/2008

- NOTES:
- A. All linear dimensions are in millimeters. Dimensioning and tolerancing per ASME Y14.5M-1994.
  - B. This drawing is subject to change without notice.
  - C. QFN (Quad Flatpack No-Lead) package configuration.
  - D. This package complies to JEDEC MO-288 variation X2EFD.

RUG (R-PQFP-N10)



4210299-3/A 06/09



D0008A

# PACKAGE OUTLINE

SOIC - 1.75 mm max height

SMALL OUTLINE INTEGRATED CIRCUIT



4214825/C 02/2019

### NOTES:

- Linear dimensions are in inches [millimeters]. Dimensions in parenthesis are for reference only. Controlling dimensions are in inches. Dimensioning and tolerancing per ASME Y14.5M.
- This drawing is subject to change without notice.
- This dimension does not include mold flash, protrusions, or gate burrs. Mold flash, protrusions, or gate burrs shall not exceed .006 [0.15] per side.
- This dimension does not include interlead flash.
- Reference JEDEC registration MS-012, variation AA.



# EXAMPLE BOARD LAYOUT

D0008A

SOIC - 1.75 mm max height

SMALL OUTLINE INTEGRATED CIRCUIT



LAND PATTERN EXAMPLE  
EXPOSED METAL SHOWN  
SCALE:8X



SOLDER MASK DETAILS

4214825/C 02/2019

NOTES: (continued)

- 6. Publication IPC-7351 may have alternate designs.
- 7. Solder mask tolerances between and around signal pads can vary based on board fabrication site.

# EXAMPLE STENCIL DESIGN

D0008A

SOIC - 1.75 mm max height

SMALL OUTLINE INTEGRATED CIRCUIT



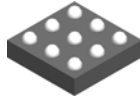
SOLDER PASTE EXAMPLE  
BASED ON .005 INCH [0.125 MM] THICK STENCIL  
SCALE:8X

4214825/C 02/2019

NOTES: (continued)

8. Laser cutting apertures with trapezoidal walls and rounded corners may offer better paste release. IPC-7525 may have alternate design recommendations.
9. Board assembly site may have different recommendations for stencil design.

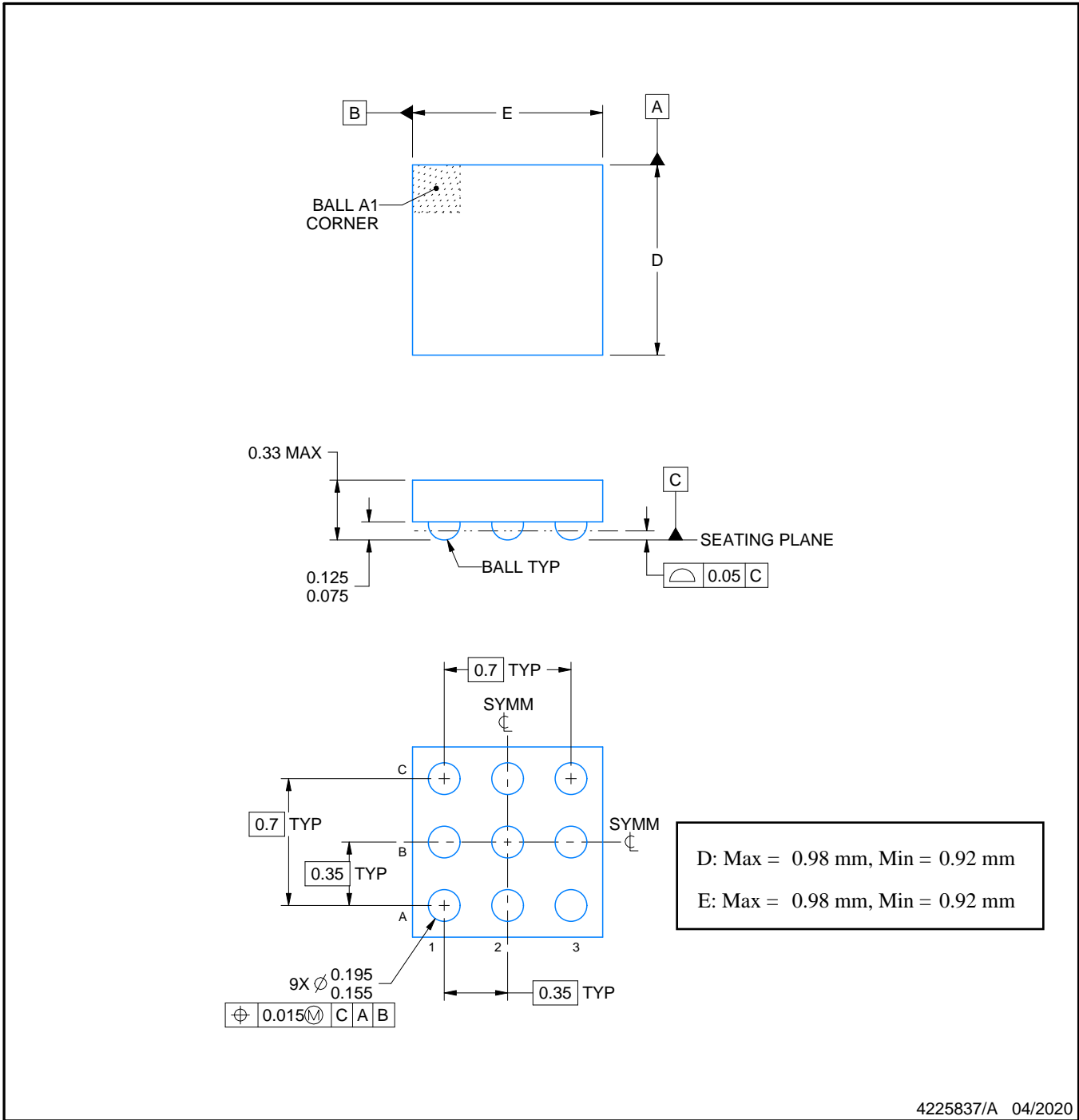
YCK0009



# PACKAGE OUTLINE

## DSBGA - 0.33 mm max height

DIE SIZE BALL GRID ARRAY



4225837/A 04/2020

NOTES:

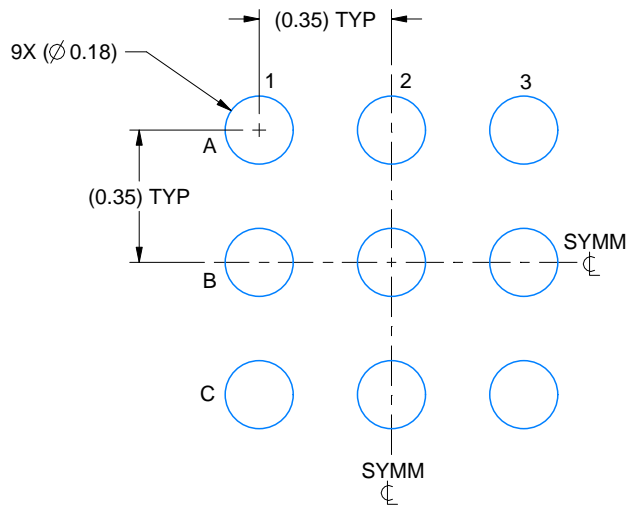
1. All linear dimensions are in millimeters. Any dimensions in parenthesis are for reference only. Dimensioning and tolerancing per ASME Y14.5M.
2. This drawing is subject to change without notice.

# EXAMPLE BOARD LAYOUT

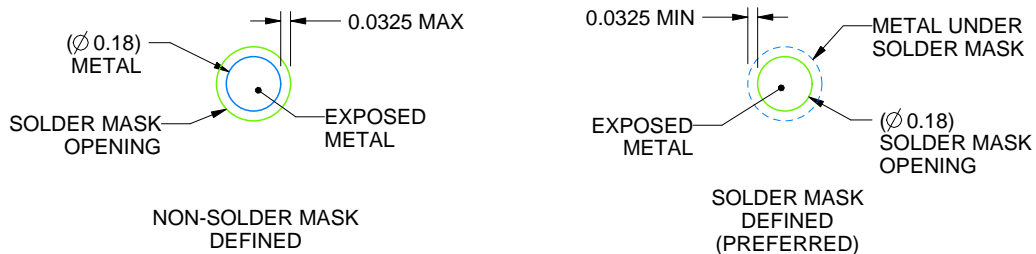
YCK0009

DSBGA - 0.33 mm max height

DIE SIZE BALL GRID ARRAY



LAND PATTERN EXAMPLE  
EXPOSED METAL SHOWN  
SCALE: 50X



SOLDER MASK DETAILS  
NOT TO SCALE

4225837/A 04/2020

NOTES: (continued)

- 3. Final dimensions may vary due to manufacturing tolerance considerations and also routing constraints. See Texas Instruments Literature No. SNVA009 ([www.ti.com/lit/snva009](http://www.ti.com/lit/snva009)).



## IMPORTANT NOTICE AND DISCLAIMER

TI PROVIDES TECHNICAL AND RELIABILITY DATA (INCLUDING DATA SHEETS), DESIGN RESOURCES (INCLUDING REFERENCE DESIGNS), APPLICATION OR OTHER DESIGN ADVICE, WEB TOOLS, SAFETY INFORMATION, AND OTHER RESOURCES "AS IS" AND WITH ALL FAULTS, AND DISCLAIMS ALL WARRANTIES, EXPRESS AND IMPLIED, INCLUDING WITHOUT LIMITATION ANY IMPLIED WARRANTIES OF MERCHANTABILITY, FITNESS FOR A PARTICULAR PURPOSE OR NON-INFRINGEMENT OF THIRD PARTY INTELLECTUAL PROPERTY RIGHTS.

These resources are intended for skilled developers designing with TI products. You are solely responsible for (1) selecting the appropriate TI products for your application, (2) designing, validating and testing your application, and (3) ensuring your application meets applicable standards, and any other safety, security, regulatory or other requirements.

These resources are subject to change without notice. TI grants you permission to use these resources only for development of an application that uses the TI products described in the resource. Other reproduction and display of these resources is prohibited. No license is granted to any other TI intellectual property right or to any third party intellectual property right. TI disclaims responsibility for, and you will fully indemnify TI and its representatives against, any claims, damages, costs, losses, and liabilities arising out of your use of these resources.

TI's products are provided subject to [TI's Terms of Sale](#) or other applicable terms available either on [ti.com](https://www.ti.com) or provided in conjunction with such TI products. TI's provision of these resources does not expand or otherwise alter TI's applicable warranties or warranty disclaimers for TI products.

TI objects to and rejects any additional or different terms you may have proposed.

Mailing Address: Texas Instruments, Post Office Box 655303, Dallas, Texas 75265  
Copyright © 2024, Texas Instruments Incorporated